

AIR SERVICE

STANDARDIZATION DESIGN MEMORANDUM
No. 16 (Issue 2) Section 1. (This cancels S.D.M.16 Issue 1, Pages 16-36)

ELECTRICAL PLUGS AND SOCKETS
BREEZE SERIES

1. In accordance with the principles and conditions set out in the Introductory sheet to the S.D.M. Series, it has been decided to limit the choice of "Breeze" type plugs and sockets to those listed in this S.D.M. as follows:-

- (a) STANDARD TYPES to be used whenever possible.
- (b) NON STANDARD TYPES not to be used for new developments.

11th May, 1953.

7/Stand/74

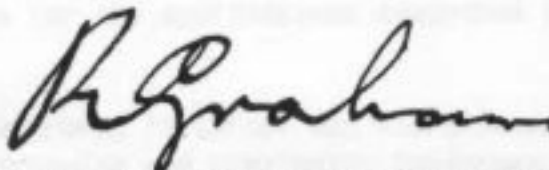

on behalf of Controller of Supplies (Air)

Enquiries concerning this S.D.M. should be made as follows:-

Standardization - A.D.S.A.E.
Design - R.D.Inst. (El.) 1

Previous issues and dates: A.D.M.500/16 (1) 3-4-43, S.D.M.16 (1) 14-2-46.

STANDARD TYPES - BREEZE SERIES - METAL CYLINDRICAL

STANDARD TYPES - BREEZE SERIES - METAL CYLINDRICAL

Notes:

- (a) The "Breeze" Series listed on pages 1 to 15 are classified "standard" and comprise "Waterproof", "Waterproof, Fireproof and Vibrationproof", "Pressurised" and "Special purpose" types.
- (b) "Waterproof" plugs and sockets have been waterproofed by suitably positioned gaskets. They have aluminium shells, and loose pins suitable for crimped connections.
- (c) "Waterproof, Fireproof and Vibrationproof" types are specifically for use on the engine side of the fireproof bulkhead and where conditions of excessive vibration are encountered. They have cadmium plated steel shells in addition to being waterproofed and the sockets have turned type inserts. The coupling nuts are drilled for wire locking if required.
- (d) "Pressurised" types are for use on pressure cabin bulkheads. They have aluminium shells and are sealed against a pressure difference of 15 lb per sq. inch.
- (e) "Special Purpose" types are for the applications described in the relevant sub-headings.
- (f) The "waterproof", and "waterproof, fireproof and vibrationproof" types of plugs and sockets are electrically and physically interchangeable. They differ in weight due to the steel shells of the fireproof range.
- (g) All standard types of "Breeze" plugs and sockets are listed in D.I.S. No. 23 copies of which may be obtained from the Plessey Company Limited, Ilford, Essex.
- (h) Where for space and/or weight consideration it is impracticable to use a standard Breeze plug or socket a miniature Mk.4 type to RCL.321 may be employed with the prior agreement of RD.Inst. (E1)1.

STANDARD TYPES - BREEZE SERIES - ALUMINIUM CYLINDRICAL

WATERPROOF (CLIMATIC)

Single Plug
5X 6181

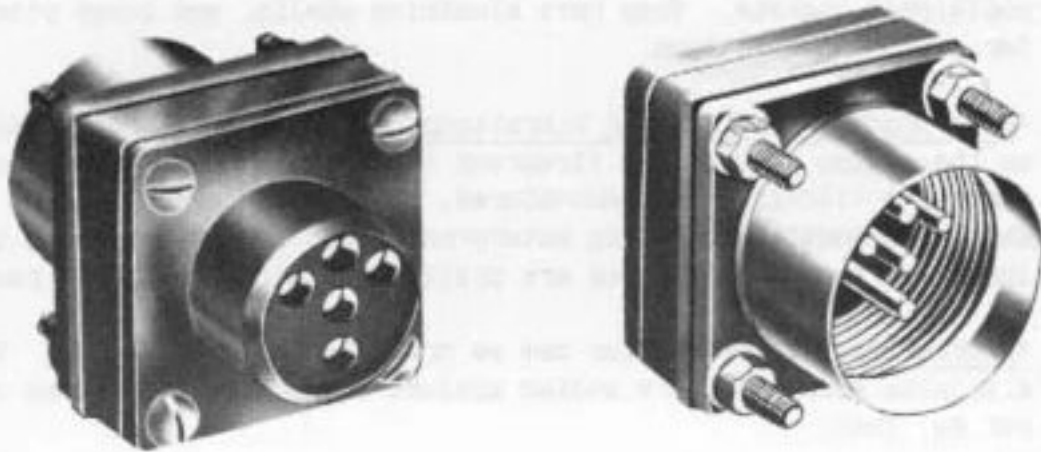

Single Socket
5X 6191



STANDARD TYPES - BREEZE SERIES - ALUMINIUM CYLINDRICAL

WATERPROOF (CLIMATIC)

A.M. Ref. No.	Plug or Socket	Single or Bulkhead	Shell Size	Maker's Assembly No.	No. of Poles at amps. stated:-				Weight lb.
					7	19	37	64	
<u>1 POLE PLUGS AND SOCKETS</u>									
5X 6011	Plug	Single	A	CZ 28092		1			.05
5X 6012	"	Bulkhead	A	CZ 28182		1			.06
5X 6014	Socket	Single	A	CZ 27902		1			.04
5X 6014	"	Bulkhead	A	CZ 27902		1			.04
<u>2 POLE PLUGS AND SOCKETS</u>									
5X 6326	Plug	Single	A	CZ 50354	2				.05
5X 6262	"	Bulkhead	A	CZ 50363	2				.06
5X 6188	Socket	Single	A	CZ 50398	2				.04
5X 6290	"	Bulkhead	A	CZ 50407	2				.04
5X 6026	Plug	Single	Z	CZ 28095		2			.08
5X 6027	"	Bulkhead	Z	CZ 28185		2			.08
5X 6029	Socket	Single	Z	CZ 27905		2			.06
5X 6030	"	Bulkhead	Z	CZ 27985		2			.06
<u>4 POLE PLUGS AND SOCKETS</u>									
5X 6179	Plug	Single	A	CZ 50355	4				.06
5X 6263	"	Bulkhead	A	CZ 50364	4				.07
5X 6189	Socket	Single	A	CZ 50399	4				.04
5X 6195	"	Bulkhead	A	CZ 50408	4				.04
5X 6327	Plug	Single	Z	CZ 50374	2	2			.07
5X 6340	"	Bulkhead	Z	CZ 50387	2	2			.09
5X 6350	Socket	Single	Z	CZ 50418	2	2			.06
5X 6361	"	Bulkhead	Z	CZ 50431	2	2			.06
5X 6329	Plug	Single	B	CZ 50358		4			.09
5X 6343	"	Bulkhead	B	CZ 50367		4			.11
5X 6352	Socket	Single	B	CZ 50402		4			.08
5X 6363	"	Bulkhead	B	CZ 50411		4			.08
5X 6318	Plug	Single	C	CZ 60492	1		3		
5X 6072	"	Bulkhead	C	CZ 28194	1		3		.14
5X 6319	Socket	Single	C	CZ 60522	1		3		
5X 6075	"	Bulkhead	C	CZ 60523	1		3		
5X 6331	Plug	Single	C	CZ 60491			4		
5X 6102	"	Bulkhead	C	CZ 28200			4		.17
5X 6354	Socket	Single	C	CZ 60525			4		
5X 6365	"	Bulkhead	C	CZ 60524			4		

STANDARD TYPES - BREEZE SERIES - ALUMINIUM CYLINDRICAL

WATERPROOF (CLINATIC)

A.M. Ref.No.	Plug or Socket	Single or Bulkhead	Shell Size	Maker's Assembly No.	No. of Poles at amps. stated:-				Weight lb.
					7	19	37	64	
5 POLE PLUGS AND SOCKETS									
5X 6181	Plug	Single	Z	CZ 50356	5				.06
5X 6264	"	Bulkhead	Z	CZ 50365	5				.08
5X 6190	Socket	Single	Z	CZ 50400	5				.07
5X 6196	"	Bulkhead	Z	CZ 50409	5				.07
5X 6183	Plug	Single	B	CZ 50359		5			.09
5X 6344	"	Bulkhead	B	CZ 50368		5			.11
5X 6192	Socket	Single	B	CZ 50403		5			.08
5X 6198	"	Bulkhead	B	CZ 50412		5			.08
6 POLE PLUGS AND SOCKETS									
5X 6328	Plug	Single	B	CZ 50375	2	4			.09
5X 6342	"	Bulkhead	B	CZ 50388	2	4			.11
5X 6351	Socket	Single	B	CZ 50419	2	4			.08
5X 6362	"	Bulkhead	B	CZ 50432	2	4			.08
5X 6096	Plug	Single	C	CZ 28109		6			.12
5X 6097	"	Bulkhead	C	CZ 28199		6			.14
5X 6099	Socket	Single	C	CZ 27919		6			.11
5X 6100	"	Bulkhead	C	CZ 27999		6			.11
5X 6335	Plug	Single	D	CZ 60495	4			2	
5X 6346	"	Bulkhead	D	CZ 56069	4			2	
5X 6309	Socket	Single	D	CZ 56065	4			2	
5X 6308	"	Bulkhead	D	CZ 56071	4			2	
8 POLE PLUGS AND SOCKETS									
5X 6332	Plug	Single	D	CZ 60493	2	2	4		.22
5X 6107	"	Bulkhead	D	CZ 28201	2	2	4		
5X 6355	Socket	Single	D	CZ 60527	2	2	4		
5X 6366	"	Bulkhead	D	CZ 60528	2	2	4		
9 POLE PLUGS AND SOCKETS									
5X 6182	Plug	Single	B	CZ 50357	9				.08
5X 6341	"	Bulkhead	B	CZ 50366	9				.10
5X 6191	Socket	Single	B	CZ 50401	9				
5X 6197	"	Bulkhead	B	CZ 50410	9				
5X 6330	Plug	Single	B	CZ 56073	7	2			.09
5X 6345	"	Bulkhead	B	CZ 56075	7	2			.11
5X 6353	Socket	Single	B	CZ 56074	7	2			
5X 6364	"	Bulkhead	B	CZ 56076	7	2			
10 POLE PLUGS AND SOCKETS									
5X 6334	Plug	Single	D	CZ 60496	6	2	2		.19
5X 6117	"	Bulkhead	D	CZ 28203	6	2	2		
5X 6357	Socket	Single	D	CZ 60526	6	2	2		
5X 6368	"	Bulkhead	D	CZ 60531	6	2	2		

STANDARD TYPES - BRESZE SERIES - ALUMINIUM CYLINDRICAL

WATERPROOF (CLIMATIC)

A.M. Ref. No.	Plug or Socket	Single or Bulkhead	Shell Size	Maker's Assembly No.	No. of Poles at amps. stated				Weight lb.
					7	19	37	64	
<u>12 POLE PLUGS AND SOCKETS</u>									
5X 6184	Plug	Single	C	CZ 50360	12				
5X 6186	"	Bulkhead	C	CZ 50369	12				
5X 6193	Socket	Single	C	CZ 50404	12				.13
5X 6199	"	Bulkhead	C	CZ 50413	12				.13
<u>13 POLE PLUGS AND SOCKETS</u>									
5X 6333	Plug	Single	D	CZ 60494	4	7	2		
5X 6112	"	Bulkhead	D	CZ 28202	4	7	2		
5X 6356	Socket	Single	D	CZ 60529	4	7	2		
5X 6367	"	Bulkhead	D	CZ 60530	4	7	2		
<u>14 POLE PLUGS AND SOCKETS</u>									
5X 6091	Plug	Single	C	CZ 28108	12	2			
5X 6092	"	Bulkhead	C	CZ 28198	12	2			
5X 6094	Socket	Single	C	CZ 27918	12	2			.13
5X 6095	"	Bulkhead	C	CZ 27998	12	2			.13
<u>16 POLE PLUGS AND SOCKETS</u>									
5X 6126	Plug	Single	D	CZ 28115	12	4			
5X 6127	"	Bulkhead	D	CZ 28205	12	4			
5X 6129	Socket	Single	D	CZ 27925	12	4			.21
5X 6130	"	Bulkhead	D	CZ 28005	12	4			.21
<u>26 POLE PLUGS AND SOCKETS</u>									
5X 6185	Plug	Single	D	CZ 50361	24	2			
5X 6265	"	Bulkhead	D	CZ 50370	24	2			
5X 6194	Socket	Single	D	CZ 50405	24	2			.23
5X 6200	"	Bulkhead	D	CZ 50414	24	2			.23
<u>27 POLE PLUGS AND SOCKETS</u>									
5X 6336	Plug	Single	E	CZ 60497	20	4	3		
5X 6347	"	Bulkhead	E	CZ 50371	20	4	3		
5X 6358	Socket	Single	E	O 60532	20	4	3		
5X 6369	"	Bulkhead	E	CZ 60533	20	4	3		

STANDARD TYPES - BREEZE SERIES - STEEL CYLINDRICAL

WATERPROOF, FIREPROOF AND VIBRATIONPROOF

5X 6002

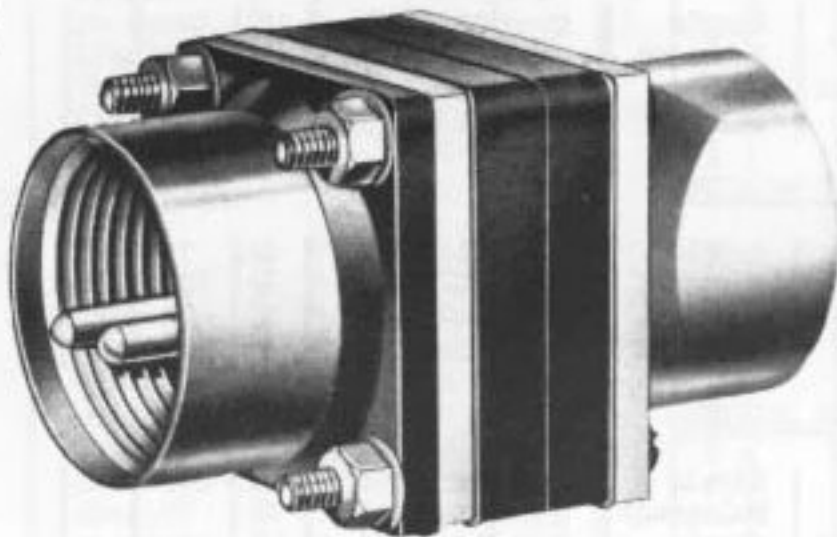

5X 6374

STANDARD TYPES - BREEZE SERIES - STEEL CYLINDRICAL

WATERPROOF, FIREPROOF AND VIBRATIONPROOF

A.M. Ref. No.	Plug or Socket	Single or Bulkhead	Shell Size	Maker's Assembly No.	No. of Poles at amps. stated:-				Weight lb.
					7	19	37	64	
<u>2 POLE PLUGS AND SOCKETS</u>									
5X 6001	Plug	Single	A	CZ 28090	2				.07
5X 6002	"	Bulkhead	A	CZ 28180	2				.09
5X 6374	Socket	Single	A	CZ 56085	2				.09
5X 6387	"	Bulkhead	A	CZ 56087	2				.09
5X 6297	Plug	Single	Z	CZ 50373		2			
5X 6378	Socket	Single	Z	CZ 64772		2			
<u>4 POLE PLUGS AND SOCKETS</u>									
5X 6006	Plug	Single	A	CZ 28091	4				.08
5X 6007	"	Bulkhead	A	CZ 28181	4				.10
5X 6375	Socket	Single	A	CZ 56089	4				.11
5X 6388	"	Bulkhead	A	CZ 56091	4				.11
5X 6031	Plug	Single	Z	CZ 28096	2	2			.09
5X 6032	"	Bulkhead	Z	CZ 28186	2	2			.13
5X 6377	Socket	Single	Z	CZ 56097	2	2			.14
5X 6390	"	Bulkhead	Z	CZ 56099	2	2			.14
5X 6056	Plug	Single	B	CZ 28101		4			.12
5X 6057	"	Bulkhead	B	CZ 28191		4			.17
5X 6381	Socket	Single	B	CZ 56109		4			.16
5X 6393	"	Bulkhead	B	CZ 56111		4			.16
5X 6337	Plug	Single	C	CZ 60478	1		3		
5X 6077	"	Bulkhead	C	CZ 28195	1		3		.22
5X 6608	Socket	Single	C	CZ 73359	1		3		
5X 6609	"	Bulkhead	C	CZ 71785	1		3		

STANDARD TYPES - BREEZE SERIES - STEEL CYLINDRICAL

WATERPROOF, FIREPROOF AND VIBRATIONPROOF

A.M. Ref. No.	Plug or Socket	Single or Bulkhead	Shell Size	Maker's Assembly No.	No. of Poles at amps. stated:-				Weight lb.
					7	19	37	64	

5 POLE PLUGS AND SOCKETS

5X 6016	Plug	Single	Z	CZ 28093	5				.09
5X 6017	"	Bulkhead	Z	CZ 28183	5				.13
5X 6376	Socket	Single	Z	CZ 56093	5				.14
5X 6389	"	Bulkhead	Z	CZ 56095	5				.14
5X 6061	Plug	Single	B	CZ 28102		5			.13
5X 6062	"	Bulkhead	B	CZ 28192		5			.18
5X 6382	Socket	Single	B	CZ 64770		5			.16
5X 6610	"	Bulkhead	B	CZ 66955		5			.16

6 POLE PLUGS AND SOCKETS

5X 6041	Plug	Single	B	CZ 28098	2	4			.13
5X 6042	"	Bulkhead	B	CZ 28138	2	4			.18
5X 6380	Socket	Single	B	CZ 56105	2	4			.16
5X 6392	"	Bulkhead	B	CZ 56107	2	4			.16
5X 6338	Plug	Single	D	CZ 60481	4			2	
5X 6349	"	Bulkhead	D	CZ 56070	4			2	.31
5X 6611	Socket	Single	D	CZ 71764	4			2	.36
5X 6612	"	Bulkhead	D	CZ 71794	4			2	.36

9 POLE PLUGS AND SOCKETS

5X 6036	Plug	Single	B	CZ 28097	9				.11
5X 6037	"	Bulkhead	B	CZ 28187	9				.17
5X 6379	Socket	Single	B	CZ 56101	9				.18
5X 6391	"	Bulkhead	B	CZ 56103	9				.18
5X 6313	Plug	Single	B	CZ 56077	7	2			.12
5X 6348	"	Bulkhead	B	CZ 56079	7	2			.17
5X 6383	Socket	Single	B	CZ 64771	7	2			.16
5X 6613	"	Bulkhead	B	CZ 71784	7	2			.16

STANDARD TYPES - BREEZE SERIES - STEEL CYLINDRICAL

WATERPROOF, FIREPROOF AND VIBRATIONPROOF

A.M. Ref. No.	Plug or Socket	Single or Bulkhead	Shell Size	Maker's Assembly No.	No. of Poles at amps. stated:-				Weight lb.
					7	19	37	64	
<u>12 POLE PLUGS AND SOCKETS</u>									
5X 6086	Plug	Single	C	CZ 28107	12				.15
5X 6087	"	Bulkhead	C	CZ 28197	12				.21
5X 6384	Socket	Single	C	CZ 56113	12				.24
5X 6394	"	Bulkhead	C	CZ 56115	12				.24
<u>14 POLE PLUGS AND SOCKETS</u>									
5X 6207	Plug	Single	C	CZ 50377	12	2			.16
5X 6291	"	Bulkhead	C	CZ 50390	12	2			.22
5X 6385	Socket	Single	C	CZ 64517	12	2			.24
5X 6614	"	Bulkhead	C	CZ 71786	12	2			.24
<u>16 POLE PLUGS AND SOCKETS</u>									
5X 6284	Plug	Single	D	CZ 50383	12	4			.40
5X 6386	Socket	Single	D	CZ 64773	12	4			
<u>26 POLE PLUGS AND SOCKETS</u>									
5X 6131	Plug	Single	D	CZ 28116	24	2			.23
5X 6132	"	Bulkhead	D	CZ 28206	24	2			.31
5X 6615	Socket	Single	D	CZ 71763	24	2			.41
5X 6616	"	Bulkhead	D	CZ 71793	24	2			.41
<u>27 POLE PLUGS AND SOCKETS</u>									
5X 6339	Plug	Single	E	CZ 60483	20	4	3		.42
5X 6142	"	Bulkhead	E	CZ 28208	20	4	3		
5X 6617	Socket	Single	E	CZ 71756	20	4	3		
5X 6618	"	Bulkhead	E	CZ 71795	20	4	3		

STANDARD TYPES - BREEZE SERIES - ALUMINIUM CYLINDRICAL

PRESSURISED BULKHEAD PLUGS



Bulkhead Pressurised Plug
5X 6058

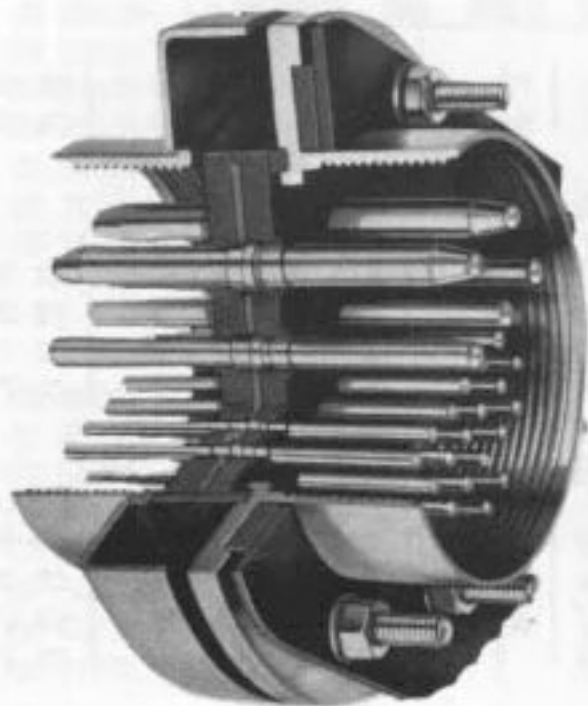

Section of typical plug.

STANDARD TYPES - BREEZE SERIES - ALUMINIUM CYLINDRICAL

PRESSURISED BULKHEAD PLUGS

A.M. Ref. No.	Shell Size	Maker's Assembly No.	No. of Poles at amps. stated:-				Weight lb.
			7	19	37	64	
<u>1 POLE</u>							
5X 6013	A	CZ 28033		1			.11
<u>2 POLE</u>							
5X 6003	A	CZ 28031	2				.11
5X 6028	Z	CZ 28036		2			.14
<u>4 POLE</u>							
5X 6008	A	CZ 28032	4				.11
5X 6033	Z	CZ 28037	2	2			.15
5X 6058	B	CZ 28042		4			.19
5X 6078	C	CZ 28046	1		3		
5X 6103	C	CZ 28051			4		
<u>5 POLE</u>							
5X 6018	Z	CZ 28034	5				.14
5X 6063	B	CZ 28043		5			.20
<u>6 POLE</u>							
5X 6043	B	CZ 28039	2	4			.19
5X 6098	C	CZ 28050		6			.24
5X 6310	D	CZ 57216	4			2	.38
<u>8 POLE</u>							
5X 6108	D	CZ 28052	2	2	4		.44
<u>9 POLE</u>							
5X 6038	B	CZ 28038	9				.18
5X 6422	B	CZ 57212	7	2			.19
<u>10 POLE</u>							
5X 6118	D	CZ 28054	6	2	2		.39
<u>12 POLE</u>							
5X 6088	C	CZ 28048	12				.23
<u>13 POLE</u>							
5X 6113	D	CZ 28053	4	7	2		.40
<u>14 POLE</u>							
5X 6093	C	CZ 28049	12	2			.25
<u>16 POLE</u>							
5X 6128	D	CZ 28056	12	4			.35
<u>26 POLE</u>							
5X 6133	D	CZ 28057	24	2			.38
<u>27 POLE</u>							
5X 6143	E	CZ 28059	20	4	3		.48

SPECIAL PURPOSE TYPES - BREEZE SERIES - CYLINDRICAL

CONSTANTAN TYPES - for thermocouples

STEEL SHELLS

A.M. Ref.No.	Plug or Socket	Single or Bulkhead	Shell Size	Maker's Assembly No.	No. of Poles at amps. stated:			Remarks	Weight lb.
					7	19	37		
5X 2881	Plug	Bulkhead	B	CZ 22580		4		Pressurised	
5X 6598	"	"	B	CZ 56000		4			
5X 2882	Socket	Single	B	CZ 22579		4			
5X 2883	Socket	Bulkhead	B	CZ 22579A/3		4		Pressurised	
5X 6147	Plug	"	C	CZ 27810/2			4		
5X 6148	"	"	C	CZ 49164			4		
5X 6149	Socket	Single	C	CZ 27811/3			4		
5X 6150	"	Bulkhead	C	CZ 27811A/3			4		

QUICK RELEASE TYPES

ALUMINIUM SHELLS

5X 3158	Plug	Single	B	CZ 19145	1	3		(For jettisoning purposes)	.23
5X 3160	Socket	"	B	CZ 19146	1	3			.11
5X 95	Plug	"	B	CZ 12353		5			.24
5X 1286	Socket	"	B	CZ 10348		5			.11
5X 6158	Plug	"	B	CZ 51396	7	2			.24
	"	Bulkhead	B	CZ 53206	7	2			.21
5X 6159	Socket	Single	B	CZ 51395	7	2			.11

PULSOMETER TYPES

ALUMINIUM SHELLS

5X 2183	Plug		A	CZ 22238	2			Mates with 5X 101 or 5X 6004 for fuel pumps	.06
---------	------	--	---	----------	---	--	--	--	-----

SHORT REACH SOCKET AND ELBOW ASSEMBLY

BRASS

5X 2928	Socket		A	CZ 27004	2			Mates with plug assemblies:- 5X 6001, 6002, 6003	.06
5X 6156	"		A	CZ 50951	4			Mates with plug assemblies:- 5X 6006, 6007	

SPECIAL PURPOSE TYPES - BREEZE SERIES - CYLINDRICAL

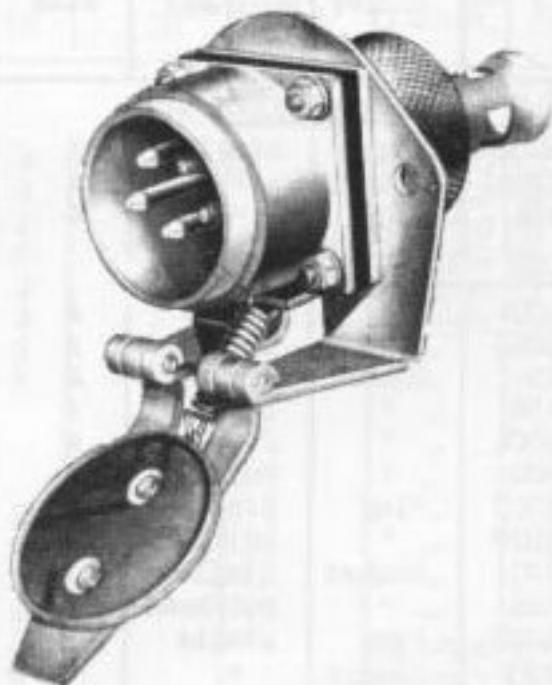

Quick Release Type
5X 95 and 5X 1286

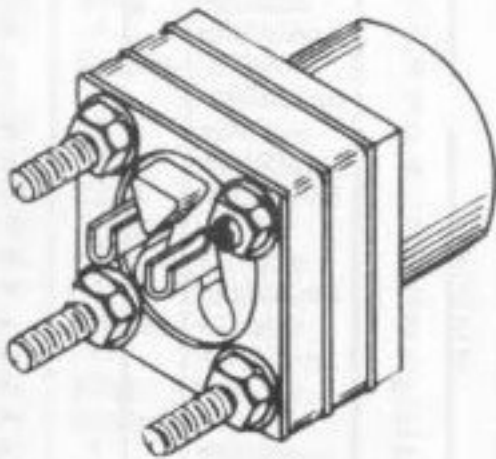

Pulsometer Type
5X 2183

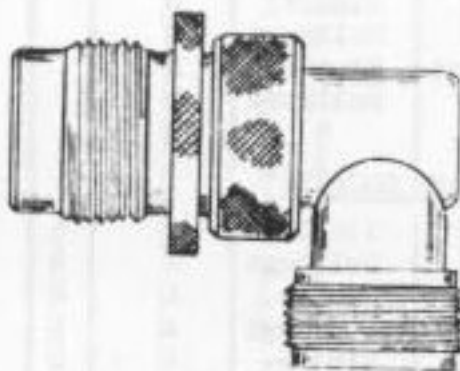

5X 2928

Short Reach Socket and Elbow

NON STANDARD TYPES - BREEZE SERIES - METAL CYLINDRICAL

A.M. Ref. No.	Plug or Socket	Single or Bulkhead	Shell Size	No. of Poles at amps. stated:-				Superseded by:-	
				7	19	37	64	Alumin.	Steel
1 POLE - PLUG AND SOCKET									
5X 4004	Plug	Single	A		1			5X 6011	5X 6302
5X 6302	Socket	"	A		1			5X 6014	CZ 50416*
5X 104	"	"	A		1			5X 6014	CZ 50416*
2 POLE - PLUGS AND SOCKETS									
5X 4001	Plug	Single	A	2				5X 6326	5X 6001
5X 4066	"	Bulkhead	A	2				5X 6262	5X 6002
5X 101	Socket	Single	A	2				5X 6188	5X 6004
5X 162	"	Bulkhead	A	2				5X 6290	5X 6005
5X 6004	"	Single	A	2				5X 6188	5X 6374
5X 6005	"	Bulkhead	A	2				5X 6290	5X 6387
5X 4007	Plug	Single	Z		2			5X 6026	5X 6297
5X 4070	"	Bulkhead	Z		2			5X 6027	CZ 50386*
5X 107	Socket	Single	Z		2			5X 6029	5X 6298
5X 166	"	Bulkhead	Z		2			5X 6030	CZ 50430*
5X 4022	Plug	Single	B		2			-	-
5X 123	Socket	"	B		2			-	-
3 POLE - PLUGS AND SOCKETS									
5X 4002	Plug	Single	A	3				-	-
5X 4067	"	Bulkhead	A	3				-	-
5X 102	Socket	Single	A	3				-	-
5X 163	"	Bulkhead	A	3				-	-
5X 4025	Plug	Single	B			3		-	-
5X 4079	"	Bulkhead	B			3		-	-
5X 127	Socket	Single	B			3		-	-
5X 175	"	Bulkhead	B			3		-	-
5X 4052	Plug	Single	D				3	-	-
5X 155	Socket	"	D				3	-	-
5X 6136	Plug	Single	D				3	-	-
5X 6137	"	Bulkhead	D				3	-	-
5X 6139	Socket	Single	D				3	-	-
5X 6140	"	Bulkhead	D				3	-	-
5X 6138	Plug	"	D				3	-	-
4 POLE - PLUGS AND SOCKETS									
5X 4003	Plug	Single	A	4				5X 6179	5X 6006
5X 4068	"	Bulkhead	A	4				5X 6263	5X 6007
5X 103	Socket	Single	A	4				5X 6189	5X 6009
5X 164	"	Bulkhead	A	4				5X 6195	5X 6010
5X 6009	"	Single	A	4				5X 6189	5X 6375
5X 6010	"	Bulkhead	A	4				5X 6195	5X 6388

* Not adopted as standard item

NON STANDARD TYPES - BREEZE SERIES - METAL CYLINDRICAL									
A.M. Ref. No.	Plug or Socket	Single or Bulkhead	Shell Size	No. of Poles at amps. stated:-				Alumin.	Steel
				7	19	37	64		
4 POLE - PLUGS AND SOCKETS									
5X 4008	Plug	Single	Z	2	2				
5X 4071	"	Bulkhead	Z	2	2			5X 6327	5X 6031
5X 108	Socket	Single	Z	2	2			5X 6340	5X 6032
5X 167	"	Bulkhead	Z	2	2			5X 6350	5X 6034
5X 6034	"	Single	Z	2	2			5X 6361	5X 6035
5X 6035	"	Bulkhead	Z	2	2			5X 6350	5X 6377
5X 4014	Plug	Single	B	1	3			5X 6361	5X 6390
5X 114	Socket	"	B	1	3			-	-
5X 4078	Plug	Bulkhead	B	1		3		-	-
5X 126	Socket	Single	B	1		3		-	-
5X 174	"	Bulkhead	B	1		3		-	-
5X 4016	Plug	Single	B	2	2			-	-
5X 4074	"	Bulkhead	B	2	2			-	-
5X 116	Socket	Single	B	2	2			-	-
5X 170	"	Bulkhead	B	2	2			-	-
5X 4023	Plug	Single	B		4			5X 6329	5X 6056
5X 4077	"	Bulkhead	B		4			5X 6343	5X 6057
5X 124	Socket	Single	B		4			5X 6352	5X 6059
5X 173	"	Bulkhead	B		4			5X 6363	5X 6060
5X 6059	"	Single	B		4			5X 6352	5X 6381
5X 6060	"	Bulkhead	B		4			5X 6363	5X 6393
5X 6073	Plug	Bulkhead	C	1		3		5X 6072	5X 6077
5X 6075	Socket	"	C	1		3		5X 6075	5X 6371
5X 4026	Plug	Single	C	1		3		5X 6318	5X 6337
5X 4080	"	Bulkhead	C	1		3		5X 6072	5X 6079
5X 128	Socket	Single	C	1		3		5X 6319	5X 6359
5X 176	"	Bulkhead	C	1		3		5X 6075	5X 6341
5X 6076	Plug	Single	C	1		3		5X 6318	5X 6337
5X 6079	Socket	Single	C	1		3		5X 6319	5X 6359
5X 6080	"	Bulkhead	C	1		3		5X 6075	5X 6371
5X 6071	Plug	Single	C	1		3		5X 6318	5X 6337
5X 6074	Socket	"	C	1		3		5X 6319	5X 6359
5X 6359	"	"	C	1		3		5X 6608	5X 6608
5X 6371	"	Bulkhead	C	1		3		5X 6604	5X 6609
5X 6101	Plug	Single	C			4		5X 6331	CZ 60477
5X 6104	Socket	"	C			4		5X 6354	CZ 60501
5X 6105	"	Bulkhead	C			4		5X 6365	CZ 60500
5X 4087	Plug	"	C			4		5X 6102	CZ 50392
5X 138	Socket	Single	C			4		5X 6354	CZ 60501
5X 183	"	Bulkhead	C			4		5X 6365	CZ 60500
5X 53	Plug	Single	D		1	3		-	-
5X 156	Socket	"	D		1	3		-	-
5X 54	Plug	"	D		1	3		-	-
5X 1554	"	"	E			2	2	-	-
5X 1555	Socket	"	E			2	2	-	-

* Not adopted as standard item

NON STANDARD TYPES - BREEZE SERIES - METAL CYLINDRICAL									
A.M. Ref.No.	Plug or Socket	Single or Bulkhead	Shell Size	No. of Poles at amps. stated:-				Superseded by:-	
				7	19	37	64	Alumin.	Steel
5 POLE - PLUGS AND SOCKETS									
5X 4005	Plug	Single	Z	5				5X 6181	5X 6016
5X 4069	"	Bulkhead	Z	5				5X 6264	5X 6017
5X 105	Socket	Single	Z	5				5X 6190	5X 6019
5X 165	"	Bulkhead	Z	5				5X 6196	5X 6020
5X 6019	"	Single	Z	5				5X 6190	5X 6376
5X 6020	"	Bulkhead	Z	5				5X 6196	5X 6389
5X 4015	Plug	Single	B	1	4			-	-
5X 115	Socket	"	B	1	4			-	-
5X 4018	Plug	"	B	3	2			-	-
5X 118	Socket	"	B	3	2			-	-
5X 4009	Plug	Single	B	5				-	-
5X 109	Socket	"	B	5				-	-
5X 4024	Plug	"	B		5			5X 6183	5X 6061
5X 125	Socket	"	B		5			5X 6192	5X 6064
5X 6064	"	"	B		5			5X 6192	5X 6382
5X 6065	"	Bulkhead	B		5			5X 6198	5X 6610
6 POLE - PLUGS AND SOCKETS									
5X 4017	Plug	Single	B	2	4			5X 6328	5X 6041
5X 117	Socket	"	B	2	4			5X 6351	5X 6044
5X 6044	"	"	B	2	4			-	-
5X 6045	"	Bulkhead	B	2	4			-	-
5X 4027	Plug	Single	C	3		3		-	-
5X 4081	"	Bulkhead	C	3		3		-	-
5X 129	Socket	Single	C	3		3		-	-
5X 177	"	Bulkhead	C	3		3		-	-
5X 4035	Plug	Single	C		6			5X 6096	CZ 50378*
5X 137	Socket	"	C		6			5X 6099	CZ 50422*
5X 4038	Plug	Single	D	4			2	-	-
5X 4088	"	Bulkhead	D	4			2	-	-
5X 141	Socket	Single	D	4			2	-	-
5X 184	"	Bulkhead	D	4			2	-	-
5X 6299	"	Single	D	4			2	5X 6309	5X 6611
5X 6372	"	Bulkhead	D	4			2	5X 6308	5X 6612
7 POLE - PLUGS AND SOCKETS									
5X 4006	Plug	Single	Z	7				-	-
5X 106	Socket	"	Z	7				-	-
5X 4010	Plug	"	B	7				-	-
5X 4072	"	Bulkhead	B	7				-	-
5X 110	Socket	Single	B	7				-	-
5X 168	"	Bulkhead	B	7				-	-
5X 6066	Plug	Single	B	7				-	-
5X 6067	"	Bulkhead	B	7				-	-
5X 6069	Socket	Single	B	7				-	-
5X 6070	"	Bulkhead	B	7				-	-
5X 6068	Plug	Bulkhead	B	7				-	-
5X 36	"	Single	C		7			-	-
5X 139	Socket	"	C		7			-	-

* Not adopted as standard item

NON STANDARD TYPES - BREEZE SERIES - METAL CYLINDRICAL									
A.M. Ref. No.	Plug or Socket	Single or Bulkhead	Shell Size	No. of Poles at amps. stated:-				Superseded by:-	
				7	19	37	64	Alumin.	Steel
8 POLE - PLUGS AND SOCKETS									
5X 75	Plug	Bulkhead	B	6	2			-	-
5X 119	Socket	Single	B	6	2			-	-
5X 171	"	Bulkhead	B	6	2			-	-
5X 4028	Plug	Single	C	5	3			-	-
5X 4082	"	Bulkhead	C	5	3			-	-
5X 130	Socket	Single	C	5	3			-	-
5X 178	"	Bulkhead	C	5	3			-	-
5X 4037	Plug	Single	D	2	2	4		5X 6332	CZ 50393 X
5X 6106	"	Single	D	2	2	4		5X 6332	CZ 50393 X
5X 140	Socket	"	D	2	2	4		5X 6355	CZ 60503 X
5X 6109	"	"	D	2	2	4		5X 6355	CZ 60503 X
5X 6110	Socket	Bulkhead	D	2	2	4		5X 6366	CZ 60504 X
9 POLE - PLUGS AND SOCKETS									
5X 4021	Plug	Single	B	7	2				
5X 4076	"	Bulkhead	B	7	2				
5X 122	Socket	Single	B	7	2				
5X 172	"	Bulkhead	B	7	2				
5X 6321	"	Single	B	7	2			5X 6353	5X 6383
5X 6370	"	Bulkhead	B	7	2			5X 6364	5X 6613
5X 4011	Plug	Single	B	9				5X 6182	5X 6036
5X 111	Socket	"	B	9				5X 6191	5X 6039
5X 6039	"	"	B	9				5X 6191	5X 6379
5X 6040	"	Bulkhead	B	9				5X 6197	5X 6391
10 POLE - PLUGS AND SOCKETS									
5X 4020	Plug	Single	B	8	2				
5X 121	Socket	"	B	8	2				
5X 4012	Plug	"	B	10					
5X 4073	"	Bulkhead	B	10					
5X 112	Socket	Single	B	10				-	-
5X 169	"	Bulkhead	B	10				-	-
5X 6153	Plug	Single	B	10				-	-
5X 6154	"	Bulkhead	B	10				-	-
5X 6155	"	Bulkhead	B	10				-	-
5X 6151	Socket	Single	B	10				-	-
5X 6152	"	Bulkhead	B	10				-	-
5X 4029	Plug	"	C	6	4			-	-
5X 131	Socket	"	C	6	4			-	-
5X 4030	Plug	"	C	7	3			-	-
5X 4083	"	Bulkhead	C	7	3			-	-
5X 132	Socket	Single	C	7	3			-	-
5X 179	"	Bulkhead	C	7	3			-	-
5X 4039	Plug	Single	D	4	6			-	-
5X 142	Socket	"	D	4	6			-	-
5X 4041	Plug	"	D	6	2	2		5X 6334	CZ 60482 X
5X 144	Socket	"	D	6	2	2		5X 6357	CZ 60502 X
5X 6116	Plug	Single	D	6	2	2		5X 6334	CZ 60482 X
5X 6119	Socket	"	D	6	2	2		5X 6357	CZ 60502 X
5X 6120	Socket	Bulkhead	D	6	2	2		5X 6368	CZ 60507 X

X Not adopted as standard item

NON STANDARD TYPES - BREEZE SERIES - METAL CYLINDRICAL									
A.M. Ref. No.	Plug or Socket	Single or Bulkhead	Shell Size	No. of Poles at amps. stated:-				Superseded by:-	
				7	19	37	64	Alumin.	Steel
11 POLE - PLUGS AND SOCKETS									
5X 4019	Plug	Single	B	10	1			-	-
5X 120	Socket	"	B	10	1			-	-
5X 4044	Plug	Single	D	8		3		-	-
5X 4090	"	Bulkhead	D	8		3		-	-
5X 147	Socket	Single	D	8		3		-	-
5X 186	"	Bulkhead	D	8		3		-	-
12 POLE - PLUGS AND SOCKETS									
5X 4013	Plug	Bulkhead	B	12				-	-
5X 113	Socket	"	B	12				-	-
5X 6089	Socket	Single	C	12				5X 6193	5X 6384
5X 6090	"	Bulkhead	C	12				5X 6199	5X 6394
5X 4032	Plug	"	C	12				5X 6184	5X 6086
5X 4084	"	Bulkhead	C	12				5X 6186	5X 6087
5X 134	Socket	Single	C	12				5X 6193	5X 6089
5X 180	"	Bulkhead	C	12				5X 6199	5X 6090
5X 4043	Plug	Single	D	8	4			-	-
5X 146	Socket	"	D	8	4			-	-
13 POLE - PLUGS AND SOCKETS									
5X 4031	Plug	Single	C	10	3			-	-
5X 133	Socket	"	C	10	3			-	-
5X 4040	Plug	"	D	4	7	2		5X 6333	CZ 60480 *
5X 143	Socket	"	D	4	7	2		5X 6356	CZ 60505 *
5X 6111	Plug	"	D	4	7	2		5X 6333	CZ 60480 *
5X 6114	Socket	"	D	4	7	2		5X 6356	CZ 60505 *
5X 6115	"	"	D	4	7	2		5X 6367	CZ 60506 *
14 POLE - PLUGS AND SOCKETS									
5X 4033	Plug	Single	C	12	2			5X 6091	5X 6207
5X 4085	"	Bulkhead	C	12	2			5X 6092	5X 6291
5X 135	Socket	Single	C	12	2			5X 6094	5X 6201
5X 181	"	Bulkhead	C	12	2			5X 6095	5X 6292
5X 6201	"	Single	C	12	2			5X 6094	5X 6385
5X 6292	"	Bulkhead	C	12	2			5X 6095	5X 6614

* Not adopted as standard item

NON STANDARD TYPES - BREEZE SERIES - METAL CYLINDRICAL

A.M. Ref.No.	Plug or Skt.	Single or Bulkhead	Shell Size	No. of Poles at amps. stated:-				Superseded by:-	
				7	19	37	64	Alumin.	Steel
16 POLE - PLUGS AND SOCKETS									
5X 4034	Plug	Single	C	16				-	-
5X 4086	"	Bulkhead	C	16				-	-
5X 136	Socket	Single	C	16				-	-
5X 182	"	Bulkhead	C	16				-	-
5X 4042	Plug	Single	D	7	7	2		-	-
5X 4089	"	Bulkhead	D	7	7	2		-	-
5X 145	Socket	Single	D	7	7	2		-	-
5X 185	"	Bulkhead	D	7	7	2		-	-
5X 4045	Plug	Single	D	9	4	3		-	-
5X 148	Socket	"	D	9	4	3		-	-
5X 4048	Plug	"	D	12	4			5X 6126	5X 6284
5X 4091	"	Bulkhead	D	12	4			5X 6127	CZ 50396 *
5X 151	Socket	Single	D	12	4			5X 6129	5X 6307
5X 187	"	Bulkhead	D	12	4			5X 6130	CZ 50440 *
5X 1946	"	Single	D	12	4			5X 6129	5X 6307
5X 4049	Plug	"	D	13		3		-	-
5X 152	Socket	"	D	13		3		-	-

* Not adopted as standard item

NON STANDARD TYPES - BREEZE SERIES - METAL CILYINDRICAL

A.M. Ref. No.	Plug or Skt.	Single or Bulkhead	Shell Size	No. of Poles at amps. stated:-				Superseded by:-	
				7	19	37	64	Alumin.	Steel
<u>26 POLE - PLUGS AND SOCKETS</u>									
5X 4051	Plug	Single	D	24	2			5X 6185	5X 6131
5X 2128	"	Bulkhead	D	24	2			5X 6265	5X 6132
5X 154	Socket	Single	D	24	2			5X 6194	5X 6134
5X 2130	"	Bulkhead	D	24	2			5X 6200	5X 6135
5X 1947	"	Single	D	24	2			5X 6194	5X 6134
5X.6134	"	"	D	24	2			5X 6194	5X 6615
5X.6135	"	Bulkhead	D	24	2			5X 6200	5X 6616
<u>27 POLE - PLUGS AND SOCKETS</u>									
5X 4056	Plug	Single	E	20	4	3		5X 6336	5X 6339
5X 2129	"	Bulkhead	E	20	4	3		5X 6347	5X 6142
5X 159	Socket	Single	E	20	4	3		5X 6358	5X 6360
5X 2131	"	Bulkhead	E	20	4	3		5X 6369	5X 6145
5X 6141	Plug	Single	E	20	4	3		5X 6336	5X 6339
5X 6144	Socket	"	E	20	4	3		5X 6358	5X 6360
5X 6145	"	Bulkhead	E	20	4	3		5X 6369	5X 6373
5X 6360	"	Single	E	20	4	3		5X 6358	5X 6617
5X 6373	"	Bulkhead	E	20	4	3		5X 6369	5X 6618

OBSOLETE TYPES - BREEZE SERIES - METAL CYLINDRICAL								
A.M. Ref. No.	Plug or Socket	Single or Bulkhead	Shell Size	No. of Poles at amps. stated:-				
				7	19	37	64	200
<u>2 POLE PLUGS AND SOCKETS</u>								
5X 1	Plug	Single	A	2				
<u>3 POLE PLUGS AND SOCKETS</u>								
5X 57	Plug	Single	E		1			2
5X 58	Plug	"	E		1			2
5X 59	Plug	"	E		1			2
5X 60	Plug	"	E		1			2
5X 1567	Plug	"	E		1			2
5X 1568	Plug	"	E		1			2
5X 93	Plug	Bulkhead	E		1			2
5X 160	Socket	Single	E		1			2
5X 189	Socket	Bulkhead	E		1			2
5X 62	Plug	Single	F					3
5X 63	Plug	"	F					3
5X 64	Plug	"	F					3
5X 65	Plug	"	F					3
5X 1589	Plug	"	F					3
5X 1706	Plug	"	F					3
5X 1707	Plug	"	F					3
5X 1708	Plug	"	F					3
5X 1709	Plug	"	F					3
5X 61	Plug	Bulkhead	F					3
5X 94	Plug	Bulkhead	F					3
5X 161	Socket	Single	F					3
5X 190	Socket	Bulkhead	F					3
<u>4 POLE PLUGS AND SOCKETS</u>								
5X 3157	Plug	Single	B		4			
5X 3159	Socket	"	B		4			
<u>13 POLE - PLUGS AND SOCKETS</u>								
5X 4046	Plug	Single	D		11		2	
5X 149	Socket	"	D		11		2	

OBSOLETE TYPES - BREEZE SERIES - METAL CYLINDRICAL

A.M. Ref. No.	Plug or Socket	Single or Bulkhead	Shell Size	No. of Poles at amps. Stated:-			
				7	19	37	64
<u>19 POLE - PLUGS AND SOCKETS</u>							
5X 4047	Plug	Single	D	11	6	2	
5X 150	Socket	Bulkhead	D	11	6	2	
<u>20 POLE - PLUGS AND SOCKETS</u>							
5X 4050	Plug	Single	D	20			
5X 4092	"	Bulkhead	D	20			
5X 153	Socket	Single	D	20			
5X 188	"	Bulkhead	D	20			
5X 2043	"	Single	D	20			
<u>25 POLE - PLUGS AND SOCKETS</u>							
5X 4055	Plug	Single	E	9	16		
5X 158	Socket	"	E	9	16		

NUMERICAL INDEX - A.H. REFERENCE NUMBERS

A.M. Ref.No.	Page No.	A.H. Ref.No.	Page No.	A.H. Ref.No.	Page No.	A.M. Ref.No.	Page No.	A.H. Ref.No.	Page No.
5X 1	23	5X 134	20	5X 185	21	5X 4019	20	5X 4082	19
5X 36	18	5X 135	20	5X 186	20	5X 4020	19	5X 4083	19
5X 53	17	5X 136	21	5X 187	21	5X 4021	19	5X 4084	20
5X 54	17	5X 137	18	5X 188	24	5X 4022	16	5X 4085	20
5X 57	23	5X 138	17	5X 189	23	5X 4023	17	5X 4086	21
5X 58	23	5X 139	18	5X 190	23	5X 4024	18	5X 4087	17
5X 59	23	5X 140	19	5X 1286	14	5X 4025	16	5X 4088	18
5X 60	23	5X 141	18	5X 1554	17	5X 4026	17	5X 4089	21
5X 61	23	5X 142	19	5X 1555	17	5X 4027	18	5X 4090	20
5X 62	23	5X 143	20	5X 1567	23	5X 4028	19	5X 4091	21
5X 63	23	5X 144	19	5X 1568	23	5X 4029	19	5X 4092	24
5X 64	23	5X 145	21	5X 1589	23	5X 4030	19	5X 6001	9
5X 65	23	5X 146	20	5X 1706	23	5X 4031	20	5X 6002	9
5X 75	19	5X 147	20	5X 1707	23	5X 4032	20	5X 6003	13
5X 93	23	5X 148	21	5X 1708	23	5X 4033	20	5X 6004	16
5X 94	23	5X 149	23	5X 1709	23	5X 4034	21	5X 6005	16
5X 95	14	5X 150	24	5X 1946	21	5X 4035	18	5X 6006	9
5X 101	16	5X 151	21	5X 1947	22	5X 4037	19	5X 6007	9
5X 102	16	5X 152	21	5X 2043	24	5X 4038	18	5X 6008	13
5X 103	16	5X 153	24	5X 2128	22	5X 4039	19	5X 6009	16
5X 104	16	5X 154	22	5X 2129	22	5X 4040	20	5X 6010	16
5X 105	18	5X 155	16	5X 2130	22	5X 4041	19	5X 6011	5
5X 106	18	5X 156	17	5X 2131	22	5X 4042	21	5X 6012	5
5X 107	16	5X 158	24	5X 2183	14	5X 5043	20	5X 6013	13
5X 108	17	5X 159	22	5X 2881	14	5X 4044	20	5X 6014	5
5X 109	18	5X 160	23	5X 2882	14	5X 4045	21	5X 6016	10
5X 110	18	5X 161	23	5X 2883	14	5X 4046	23	5X 6017	10
5X 111	19	5X 162	16	5X 2928	14	5X 4047	24	5X 6018	13
5X 112	19	5X 163	16	5X 3157	23	5X 4048	21	5X 6019	18
5X 113	20	5X 164	16	5X 3158	14	5X 4049	21	5X 6020	18
5X 114	17	5X 165	18	5X 3159	23	5X 4050	24	5X 6026	5
5X 115	18	5X 166	16	5X 3160	14	5X 4051	22	5X 6027	5
5X 116	17	5X 167	17	5X 4001	16	5X 4052	16	5X 6028	13
5X 117	18	5X 168	18	5X 4002	16	5X 4055	24	5X 6029	5
5X 118	18	5X 169	19	5X 4003	16	5X 4056	22	5X 6030	5
5X 119	19	5X 170	17	5X 4004	16	5X 4066	16	5X 6031	9
5X 120	20	5X 171	19	5X 4005	18	5X 4067	16	5X 6032	9
5X 121	19	5X 172	19	5X 4006	18	5X 4068	16	5X 6033	13
5X 122	19	5X 173	17	5X 4007	16	5X 4069	18	5X 6034	17
5X 123	16	5X 174	16	5X 4008	17	5X 4070	16	5X 6035	17
5X 124	17	5X 175	16	5X 4009	18	5X 4071	17	5X 6036	10
5X 125	18	5X 176	17	5X 4010	18	5X 4072	18	5X 6037	10
5X 126	17	5X 177	18	5X 4011	19	5X 4073	19	5X 6038	13
5X 127	16	5X 178	19	5X 4012	19	5X 4074	17	5X 6039	19
5X 128	17	5X 179	19	5X 4013	20	5X 4076	19	5X 6040	19
5X 129	18	5X 180	20	5X 4014	17	5X 4077	17	5X 6041	10
5X 130	19	5X 181	20	5X 4015	18	5X 4078	17	5X 6042	10
5X 131	19	5X 182	21	5X 4016	17	5X 4079	16	5X 6043	13
5X 132	19	5X 183	17	5X 4017	18	5X 4080	17	5X 6044	18
5X 133	20	5X 184	18	5X 4018	18	5X 4081	18		

NUMERICAL INDEX - A.M. REFERENCE NUMBERS

A.M. Ref. No.	Page No.	A.M. Ref. No.	Page No.	A.M. Ref. No.	Page No.	A.M. Ref. No.	Page No.	A.M. Ref. No.	Page No.
5X 6045	18	5X 6109	19	5X 6185	7	5X 6340	5	5X 6389	10
5X 6056	9	5X 6110	19	5X 6186	7	5X 6341	6	5X 6390	9
5X 6057	9	5X 6111	20	5X 6188	5	5X 6342	6	5X 6391	10
5X 6058	13	5X 6112	7	5X 6189	5	5X 6343	5	5X 6392	10
5X 6059	17	5X 6113	13	5X 6190	6	5X 6344	6	5X 6393	9
5X 6060	17	5X 6114	20	5X 6191	6	5X 6345	6	5X 6394	11
5X 6061	10	5X 6115	20	5X 6192	6	5X 6346	6	5X 6422	13
5X 6062	10	5X 6116	29	5X 6193	7	5X 6347	7	5X 6598	14
5X 6063	13	5X 6117	6	5X 6194	7	5X 6348	10	5X 6608	9
5X 6064	18	5X 6118	13	5X 6195	5	5X 6349	10	5X 6609	9
5X 6065	18	5X 6119	19	5X 6196	6	5X 6350	5	5X 6610	10
5X 6066	18	5X 6120	19	5X 6197	6	5X 6351	6	5X 6611	10
5X 6067	18	5X 6126	7	5X 6198	6	5X 6352	5	5X 6612	10
5X 6068	18	5X 6127	7	5X 6199	7	5X 6353	6	5X 6613	10
5X 6069	18	5X 6128	13	5X 6200	7	5X 6354	5	5X 6614	11
5X 6070	18	5X 6129	7	5X 6201	20	5X 6355	6	5X 6615	11
5X 6071	17	5X 6130	7	5X 6207	11	5X 6356	7	5X 6616	11
5X 6072	5	5X 6131	11	5X 6262	5	5X 6357	6	5X 6617	11
5X 6073	17	5X 6132	11	5X 6263	5	5X 6358	7	5X 6618	11
5X 6074	17	5X 6133	13	5X 6264	6	5X 6359	17		
5X 6075	17	5X 6134	22	5X 6265	7	5X 6360	22		
5X 6076	17	5X 6135	22	5X 6284	11	5X 6361	5		
5X 6077	9	5X 6136	16	5X 6290	5	5X 6362	6		
5X 6078	13	5X 6137	16	5X 6291	11	5X 6363	5		
5X 6079	17	5X 6138	16	5X 6292	20	5X 6364	6		
5X 6080	17	5X 6139	16	5X 6297	9	5X 6365	5		
5X 6086	11	5X 6140	16	5X 6299	18	5X 6366	6		
5X 6087	11	5X 6141	22	5X 6302	16	5X 6367	7		
5X 6088	13	5X 6142	11	5X 6308	6	5X 6368	6		
5X 6089	20	5X 6143	13	5X 6309	6	5X 6369	7		
5X 6090	20	5X 6144	22	5X 6310	13	5X 6370	19		
5X 6091	7	5X 6145	22	5X 6313	10	5X 6371	17		
5X 6092	7	5X 6147	14	5X 6318	5	5X 6372	18		
5X 6093	13	5X 6148	14	5X 6319	5	5X 6373	22		
5X 6094	7	5X 6149	14	5X 6321	19	5X 6374	9		
5X 6095	7	5X 6150	14	5X 6326	5	5X 6375	9		
5X 6096	6	5X 6151	19	5X 6327	5	5X 6376	10		
5X 6097	6	5X 6152	19	5X 6328	6	5X 6377	9		
5X 6098	13	5X 6153	19	5X 6329	5	5X 6378	9		
5X 6099	6	5X 6154	19	5X 6330	6	5X 6379	10		
5X 6100	6	5X 6155	19	5X 6331	5	5X 6380	10		
5X 6101	17	5X 6156	14	5X 6332	6	5X 6381	9		
5X 6102	5	5X 6158	14	5X 6333	7	5X 6382	10		
5X 6103	13	5X 6159	14	5X 6334	6	5X 6383	10		
5X 6104	17	5X 6179	5	5X 6335	6	5X 6384	11		
5X 6105	17	5X 6181	6	5X 6336	7	5X 6385	11		
5X 6106	21	5X 6182	6	5X 6337	9	5X 6386	11		
5X 6107	6	5X 6183	6	5X 6338	10	5X 6387	9		
5X 6108	13	5X 6184	7	5X 6339	11	5X 6388	9		