

SERVICES—HYDRAULICS IN WINGS

Ref. No.	Part No.	Description	No. Off					Material Specification	M.R. Class of Score	Plate No.	
			1	2	3	4	5				
Ae.A.-Hu-FT-548	E.200037-8	HYDRAULIC EQUIPMENT IN WINGS, ASSEMBLY						—	—		
	6F-F+W-805201-A1	Accumulator, unit (AS.920/98)						1	—	A.	
	1929	F.180037	Adaptor, bleed screws						2	DTD.364	C.
	1931	F.144413	Adaptor, 3/8" cone to 1/4" hose						2	L.1	C.
	4582	F.201231	Adaptor, bleed screw						2	—	C.
	2082	F.196060	Block, clamp, at interspar ribs "A" and "C"						5	LFS.21	C.
	2094	F.196061	Block, clamp, at interspar rib "A"						1	LFS.21	C.
	2052	F.194338	Block, clamp, on sub spar, front spar, undercarriage girder and ribs "C," "D" and "E"						21	LFS.21	C.
	2053	F.194339	Block, clamp, on sub spar and ribs "D," "E" and "F1"						13	LFS.21	C.
	3901	F.194724	Block, clamp, on bottom skin port						2	LFS.21	C.
	3903	F.194874	Block, clamp, on port interspar rib "A"						2	LFS.21	C.
	3904	F.196078	Block, clamp, on port interspar rib "B"						1	LFS.21	C.
	3905	F.196092	Block, clamp, on port interspar rib "E" and starboard front spar						5	LFS.21	C.
	3906	F.196069	Block, clamp, on interspar rib "D"						1	LFS.21	C.
	3907	F.196070	Block, clamp, on port interspar rib "D"						1	LFS.21	C.
	2083	F.196073	Block, clamp, on interspar rib "D" and undercarriage girder						5	LFS.21	C.
	3910	F.196081	Block, clamp, on port interspar rib "C"						2	LFS.21	C.
	3913	F.195831	Block, clamp, on top skin						2	LFS.21	C.
	3914	F.196066	Block, clamp, on starboard interspar rib "A"						2	LFS.21	C.
	3915	F.194932	Block, clamp, on starboard interspar rib "C"						2	LFS.21	C.
	3916	F.196094	Block, clamp, on starboard interspar rib "C"						2	LFS.21	C.
	3917	F.196067	Block, clamp, on starboard interspar rib "D"						2	LFS.21	C.
	2079	F.196064	Block, clamp, on sub spars and rib "D"						10	LFS.21	C.
		6F-F+W-516267-1	Block, clamp, on port rib "S"						1	LFS.21	C.
		6F-F+W-516267-1	Block, clamp, on starboard rib "S"						1	LFS.21	C.
	3919	F.196068	Block, clamp, on front spar						1	LFS.21	C.
	3920	F.196093	Block, clamp, on bottom skin						2	LFS.21	C.
	4585	F.202581	Block, clamp, on inboard diaphragm						2	LFS.21	C.
	4586	F.202582	Block, clamp, on inboard diaphragm						2	LFS.21	C.
	5139	F.203396	Block, clamp, on port interspar rib "A"						2	LFS.21	C.
	5140	F.204355	Block, clamp, on port interspar rib "A"						1	LFS.21	C.
	5141	F.204356	Block, clamp, on port interspar rib "A"						1	LFS.21	C.
	5142	F.204833	Block, clamp, on port interspar rib "E"						1	LFS.21	C.
	5143	F.204834	Block, clamp, on port interspar rib "E"						1	LFS.21	C.
	5144	F.205014	Block, clamp, on port interspar rib "E"						4	LFS.21	C.
	5145	F.205189	Block, clamp, on port interspar rib "D"						2	LFS.21	C.
	5146	F.204830	Block, clamp, on port interspar rib "B"						1	LFS.21	C.
	5147	F.204831	Block, clamp, on port interspar rib "B"						1	LFS.21	C.
	5148	F.204868	Block, clamp, between interspar ribs "M" and "L"						2	LFS.21	C.
	4583	F.202489	Block, clamp, on port interspar rib "F1"						1	LFS.21	C.
	2081	F.195583	Block, clamp, on interspar rib "D"						2	LFS.21	C.
	2072	F.193854	Block, clamp, on interspar rib "F" (Mod. 197)						2	LFS.21	C.
	8301	F.206023	Block, clamp, on interspar rib "E" (Mod. 197)						2	LFS.21	C.
	8302	F.206022	Block, clamp, on interspar rib "E" (Mod. 197)						2	LFS.21	C.
	8305	F.215471	Block, clamp, on interspar rib "D" (Mod. 197)						1	LFS.21	C.
	8306	F.215472	Block, clamp, on interspar rib "D" (Mod. 197)						1	LFS.21	C.
	8309	F.215478	Block, clamp, on interspar rib "F" (Mod. 197)						2	LFS.21	C.
	8310	F.217980	Block, clamp, on interspar rib "E" (Mod. 197)						1	LFS.21	C.
	8364	F.216872	Block, clamp, on interspar rib "D" (Mod. 510)						2	LFS.21	C.
	4584	F.202490	Block, clamp, on port interspar rib "F1"						1	LFS.21	C.
5149	F.204957	Block, clamp, on top skin						1	LFS.21	C.	
	STD 2045/15/26	Bride, (zu Leitung C.189160/127 u. C.189161/140)						2			
F+W Pkt.	A 25/18	6kt.-Schraube						2			
123	AGS 2002/81	Sich.-Mutter						2			
	SP 15/8	U-Scheibe						2			

SERVICES—HYDRAULICS IN WINGS

Ref. No.	Part No.	Description	No. Off	Material Specification	M.R. Class of Score	Place No.
5150	F.205916	Block, clamp, on top skin	1	LFS.21	C.	
5151	F.204687	Block, clamp, on undercarriage girder	1	LFS.21	C.	
5152	F.204867	Block, clamp, on undercarriage girder	1	LFS.21	C.	
	F.214114	Block, clamp, on starboard interspar rib "D"	2	LFS.21		
5154	F.204869	Block, clamp, on starboard interspar rib "E"	2	LFS.21	C.	
8085	F.216870	Block, clamp, on interspar rib "D" (Mod. 510)	2	LFS.21	C.	
8085	F.214887	Block, clamp, for air pipe (Mod. 330)	2	LFS.21	C.	
5479	F.203959	Bracket, for clamp blocks on rib "C"	1	L.72	MR/C	NH.1
5155	B.201084	Bracket, mounting, for accumulator on starboard rib "F"	1	S.3	C.	NH.1
	A.205865	Channel, on rib "S"	2	—		
4873	F.201509	Clamp, supporting pipe on tail rib "G"	3	S.3	MR/C	NH.1
1047	F.187998	Clip, shuttle valve attachment, rib "D" starboard	1	S.3	C.	NH.1
1048	F.188356	Clip, shuttle valve attachment on interspar rib "F," port	1	S.3	C.	NH.1
1883	F.193723	Clip, for throttling valve	1	S.3	C.	NH.1
5156	A.201085	Clip, half, for accumulator mounting	2	S.3	C.	NH.1
4146	F.193863	Clip, for reducing valve	1	S.84	C.	NE.1
	F.217579	Clip, for air pipe on interspar rib "D" (Mod. 510)	2	L.72	L.M.	
	Std 840/14	Clip, for earthing connector on ribs "A," "C" and "E"	2	DTD.610	C.	4
	Std 850/32	Clip, securing pipes between ribs "A" and "B"	1	DTD.610		
	Std 1959/1	Clip, securing pipes	1	S.3	C.	5
	Std 2045/19/24	Clip, securing pipes on interspar rib "C"	1	—		
	Std 2045/22/24	Clip, securing pipes on interspar rib "D"	1	—		
5481	F.204992	Clip, supporting pipe on undercarriage girder	1	S.3	MR/C	NH.1
	C.223630	Details of equipment, assembly (Mod. 486)	—	—		
	A.215212-S1	Bracket, mounting for filter unit (Ae.A. Hu-FT-800)	1	—		
9421	F.215214	Clip, attachment of filter unit	1	—	C.	NG.1
	Fairey-BE.2175	Filter, unit (For spares see AP.4515P, Vol. 3)	1	—	C.	
6A/2693	N-504.015	Gauge, pressure Mk. 14LL (AS.860/8)	1	—	A.	
	Auto,Prod.-	Hose, flexible, 1/8", at aileron booster	2	—	C.	
Ae.A. Hu-FT-535	AVA.322 AX/22,5-S1	Hose, flexible, 1/8", at aileron booster	2	—	C.	
27BA/10607	Auto,Prod.-	Hose, flexible, 1/8", at aileron booster	2	—	C.	
	AVA.322 BX/22,5-S1	Jack, undercarriage, port	1	—	A.	
	Dowty-1.03665.001	Jack, undercarriage, starboard	1	—	A.	
Ae.A. Hu-FT-591	Dowty-1.03665.002	Jack, flap	2	—	A.	
27Q/1891	Dowty-07581.Y.A02	Jack, flap synchronising, port	1	—	A.	
	Dowty-07390P.AO3	Jack, flap synchronising starboard	1	—	A.	
	Dowty-07390S.AO3	Label, (Mod. 330)	1	—		
6A/2771	—	Lug, locking, for charging valve	1	S.3	C.	4
	Std 1231/3	Packing, for sequence valve	1	DTD.610	C.	4
	Std 1547/24/14	Pipe, pressure, port wing, union to union (Pre Mod. 579)	1	DTD.323	C.	
2030†	C.189160/2	Pipe, return, port wing, 4-way piece to thermal relief valve	1	DTD.323	C.	
2034†	C.189160/12	Pipe, undercarriage down, port wing break, union to union	1	DTD.323	—	
3697†	C.189160/26					

† For details see Piping Chart

SERVICES—HYDRAULICS IN WINGS

Ref. No.	Part No.	Description	No. Off	Material Specification	M.R. Class of Score	Place No.
3699†	C.189160/29	Pipe, wheel brake, port wing, union to union ...	1	DTD.323	—	
3700†	C.189160/30	Pipe, wheel brake, port wing, union to union ...	1	DTD.323	—	
3706†	C.189160/36	Pipe, power assisted aileron, port wing, union to union	1	DTD.323	—	
2040†	C.189160/37	Pipe, power assisted aileron, port wing, union to union	1	DTD.323	C.	
2041†	C.189160/42	Pipe, flap up, port wing, flap control valve to tee-piece	1	DTD.323	C.	
2042†	C.189160/43	Pipe, flap up, port wing, tee-piece to fluid jettison valve	1	DTD.323	C.	
3710†	C.189160/44	Pipe, flap up, port wing, tee-piece to tee-piece ...	1	DTD.323	—	
2043†	C.189160/45	Pipe, flap up, port wing, tee-piece to tee-piece ...	1	DTD.323	C.	
3711†	C.189160/46	Pipe, flap up, port wing, tee-piece to bleed adaptor	1	DTD.323	—	
2045†	C.189160/48	Pipe, flap up, port wing, tee-piece to union ...	1	DTD.323	C.	
3712†	C.189160/49	Pipe, flap up, union to port wing break union ...	1	DTD.323	—	
3713†	C.189160/50	Pipe, flap up, port wing, tee-piece to thermal relief valve	1	DTD.323	—	
2047†	C.189160/52	Pipe, flap down, port wing, pressure relief valve to shuttle valve	1	DTD.323	C.	
3714†	C.189160/53	Pipe, flap down, port wing, shuttle valve to throttling valve	1	DTD.323	—	
3716†	C.189160/58	Pipe, flap down, union to port wing break union ...	1	DTD.323	—	
3719†	C.189160/61	Pipe, flap air, port wing, union to union ...	1	DTD.323	—	
4477†	C.189160/71	Pipe, undercarriage up, union to restrictor valve ...	1	DTD.323	C.	
5422†	C.189160/79	Pipe, return, thermal relief valve to tee-piece ...	1	DTD.323	—	
5423†	C.189160/83	Pipe, undercarriage up, sequence valve to pressure regulator valve	1	DTD.323	—	
5424†	C.189160/84	Pipe, undercarriage up, pressure regulator valve to union (Pre Mod. 579)	1	DTD.323	—	
5425†	C.189160/85	Pipe, undercarriage up, union to union (Pre Mod. 579)	1	DTD.323	—	
5426†	C.189160/86	Pipe, aileron power assisted, union to union ...	1	DTD.323	—	
5427†	C.189160/87	Pipe, aileron power assisted, union to elbow ...	1	DTD.323	MR/C	
5292†	C.189160/88	Pipe, aileron power assisted, union to elbow ...	1	DTD.323	C.	
5428†	C.189160/89	Pipe, aileron power assisted, union to union ...	1	DTD.323	—	
5293†	C.189160/90	Pipe, aileron power assisted, union to union ...	1	DTD.323	C.	
5429	C.189160/91	Pipe, aileron power assisted, union to tee piece ...	1	DTD.323	—	
	F.249420/92	Pipe, aileron power assisted, tee-piece to jack lock	1	DTD.743	C.	
5430†	C.189160/93	Pipe, return, flexible hose to union ...	1	DTD.323	—	
5431†	C.189160/94	Pipe, return, union to union ...	1	DTD.323	—	
5432†	C.189160/95	Pipe, return, union to union ...	1	DTD.323	—	
5295†	C.189160/96	Pipe, return, union to union ...	1	DTD.323	C.	
5296†	C.189160/97	Pipe, return, union to union ...	1	DTD.323	C.	
	† C.189160/98	Pipe, return, union to non-return valve ...	1	DTD.323	—	
	† C.189160/99	Pipe, return, non-return valve to 4-way piece ...	1	DTD.323	—	
4569†	C.189160/107	Pipe, flap down, tee-piece to throttling valve ...	1	DTD.323	C.	
4562†	C.189160/108	Pipe, flap down, bleed adaptor to tee-piece ...	1	DTD.323	C.	
4567†	C.189160/110	Pipe, flap balance, tee-piece to jack "up" connection	1	DTD.323	C.	
4570†	C.189160/112	Pipe, flap balance, tee-piece to selector ...	1	DTD.323	C.	
4566†	C.189160/123	Pipe, flap balancing, union to flap down connection	1	DTD.323	C.	
5237†	C.189160/126	Pipe, flap balancing, union to union ...	1	DTD.323	C.	
5238†	C.189160/127	Pipe, flap balancing, selector to union ...	1	DTD.323	C.	
5239†	C.189160/128	Pipe, flap balancing, tee-piece to union ...	1	DTD.323	C.	
5299†	C.189160/142	Pipe, undercarriage down, 4-way piece to undercarriage jack	1	DTD.323	C.	
5302†	C.189160/147	Pipe, undercarriage down, union to 4-way piece ...	1	DTD.323	C.	
5304†	C.189160/149	Pipe, undercarriage air, non-return valve to 4-way piece	1	DTD.323	C.	
5305†	C.189160/150	Pipe, undercarriage down, 4-way piece to union ...	1	DTD.323	C.	
5306†	C.189160/151	Pipe, undercarriage down, union to jettison valve	1	DTD.323	C.	
5438†	C.189160/152	Pipe, undercarriage up, tee-piece to thermal relief valve	1	DTD.323	—	

† For details see Piping Chart

SERVICES—HYDRAULICS IN WINGS

Ref. No.	Part No	Description	No. Off	Material Specification	M.R. Class of Store	Plate No.
5308†	C.189160/155	Pipe, undercarriage up, tee-piece to jettison valve	1	DTD.323	C.	
5439†	C.189160/156	Pipe, undercarriage up, tee-piece to union (Pre Mod. 579)	1	DTD.323	—	
5442†	C.189160/159	Pipe, undercarriage air, pressure release valve to non-return valve	1	DTD.323	—	
5443†	C.189160/160	Pipe, undercarriage air, pressure release valve to union	1	DTD.323	—	
5444†	C.189160/161	Pipe, undercarriage air, union to union	1	DTD.323	—	
5446†	C.189160/163	Pipe, undercarriage up, union to elbow	1	DTD.323	—	
5447†	C.189160/165	Pipe, flap air, union to union	1	DTD.323	—	
5310†	C.189160/167	Pipe, flap down, union to union	1	DTD.323	C.	
5449†	C.189160/168	Pipe, undercarriage up, jettison valve to tee-piece ...	1	DTD.323	—	
Ae. A. Hu-PT-593b	C.189160/169-S1	Pipe, flap down, bleed adaptor to flap jack	1	Stahl	C.	
	C.189160/170-S1	Pipe, flap up, bleed adaptor to flapjack	1	Stahl	C.	
	F.249420/171	Pipe, pressure, union to flap control valve	1	DTD.745	C.	
5314†	C.189160/182	Pipe, flap air, jettison valve to union	1	DTD.323	C.	
5450†	C.189160/183	Pipe, flap air, union to atmosphere	1	DTD.323	—	
5219†	C.189160/184	Pipe, undercarriage up, restrictor valve to undercarriage jack	1	DTD.323	C.	
5286†	C.189160/193	Pipe, flap down, port wing, flap control valve to pressure relief valve	1	DTD.323	C.	
5748†	C.189160/194	Pipe, flap air, port wing, union to fluid jettison valve	1	DTD.323	—	
5749†	C.189160/196	Pipe, flap balancing, port wing break, union to union	1	DTD.323	—	
5750†	C.189160/197	Pipe, flap down, tee-piece to union	1	DTD.323	—	
5288†	C.189160/198	Pipe, flap balance, port wing break, union to tee-piece	1	DTD.323	C.	
5751†	C.189160/199	Pipe, flap balance, union to port wing break... ..	1	DTD.323	—	
5289†	C.189160/200	Pipe, undercarriage up, tee-piece to sequence valve	1	DTD.323	C.	
8202†	C.189160/214	Pipe, return, port wing, tee-piece to tee-piece (Mod. 265)	1	DTD.323	MR/C	
8203†	C.189160/215	Pipe, return, tee-piece to flap pressure relief valve ... (Mod. 265)	1	DTD.323	MR/C	
8204†	C.189160/216	Pipe, return, tee-piece to tee-piece (Mod. 265) ...	1	DTD.323	MR/C	
8205†	C.189160/217	Pipe, return, tee-piece to flap selector valve (Mod. 265)	1	DTD.323	MR/C	
8206†	C.189160/218	Pipe, return, 4-way piece to tee-piece (Mod. 265) ...	1	DTD.323	MR/C	
	F.249420/220	Pipe, wheel brake, leg pivot (B) to adaptor	1	DTD.745	—	
	F.249420/221	Pipe, recuperator, leg pivot (C) to union	1	DTD.745	—	
†	C.189160/222	Pipe, recuperator, union to union (Mod. 197) ...	1	DTD.323	—	
†	C.189160/224	Pipe, wheel brake, leg pivot (A) to 4-way piece (Mod. 197)	1	DTD.323	—	
	C.189160/229	Pipe, flap, air, fluid jettison valve to shuttle valve (Mod. 510)	1	DTD.323	—	
9087†	C.189160/231	Pipe, undercarriage up, P.R.V. to union (Mod. 579)	1	DTD.323	C.	
9088†	C.189160/232	Pipe, undercarriage up, union to union (Mod. 579)	1	DTD.323	C.	
9085†	C.189160/233	Pipe, pressure, union to P.R.V. (Mod. 579)	1	DTD.323	C.	
9086†	C.189160/234	Pipe, pressure, P.R.V. to union (Mod. 579)	1	DTD.323	C.	
9089†	C.189160/238	Pipe, undercarriage up, tee-piece to union (Mod. 579)	1	DTD.323	C.	
3416†	C.189161/2	Pipe, pressure, starboard wing, union to union ...	1	DTD.323	—	
3417†	C.189161/3	Pipe, pressure, starboard wing, union to pressure regulating valve	1	DTD.323	C.	
3418†	C.189161/4	Pipe, pressure, starboard wing, pressure regulating valve to undercarriage control valve	1	DTD.323	C.	
3419†	C.189161/5	Pipe, pressure, starboard wing, pressure regulating valve to union	1	DTD.323	C.	
3427†	C.189161/13	Pipe, return, starboard wing, tee-piece to tee-piece	1	DTD.323	—	
3428†	C.189161/14	Pipe, return, starboard wing, tee-piece to undercarriage control valve	1	DTD.323	C.	

† For details see Piping Chart

SERVICES—HYDRAULICS IN WINGS

Ref. No.	Part No.	Description	No. Off	Material Specification	M.R. Class of Store	Place No.
3430†	C.189161/16	Pipe, return, starboard wing, tee piece to thermal relief valve	1	DTD.323	C.	
3431†	C.189161/17	Pipe, return, starboard wing, tee piece to thermal relief valve	1	DTD.323	—	
3435†	C.189161/21	Pipe, return, starboard wing, tee piece to tee piece	1	DTD.323	C.	
3436†	C.189161/22	Pipe, return, starboard wing, tee piece to aileron control valve	1	DTD.323	C.	
3443†	C.189161/29	Pipe, undercarriage up, starboard wing, undercarriage control valve to 4-way piece	1	DTD.323	C.	
3445†	C.189161/31	Pipe, undercarriage up, starboard wing, 4-way piece to tee-piece	1	DTD.323	C.	
	F.249421/32	Pipe, undercarriage up, starboard wing, tee-piece to union	1	DTD.743	—	
3448†	C.189161/34	Pipe, undercarriage up, starboard wing, 4-way piece to tee-piece	1	DTD.323	—	
3461†	C.189161/47	Pipe, undercarriage down, starboard wing, shuttle valve to union	1	DTD.323	—	
3462†	C.189161/48	Pipe, undercarriage down, union to starboard wing, break	1	DTD.323	—	
3466†	C.189161/52	Pipe, undercarriage down, starboard wing, union to union	1	DTD.323	—	
3468†	C.189161/54	Pipe, undercarriage down, starboard wing, tee-piece to thermal relief valve	1	DTD.323	—	
3486†	C.189161/72	Pipe, flap up, starboard wing break to union	1	DTD.323	C.	
3487†	C.189161/73	Pipe, flap up, starboard wing, union to bleed adaptor	1	DTD.323	C.	
3489†	C.189161/75	Pipe, flap down, starboard wing break to union	1	DTD.323	—	
3490†	C.189161/76	Pipe, flap down, starboard wing, union to bleed adaptor	1	DTD.323	C.	
3494†	C.189161/80	Pipe, flap balance, starboard wing break to union	1	DTD.323	C.	
5452†	C.189161/97	Pipe, undercarriage up, tee-piece to restrictor valve	1	DTD.323	—	
5317†	C.189161/98	Pipe, undercarriage up, tee-piece to thermal relief valve	1	DTD.323	C.	
5453†	C.189161/99	Pipe, return, thermal relief valve to tee-piece	1	DTD.323	—	
5318†	C.189161/100	Pipe, return, tee-piece to tee-piece	1	DTD.323	C.	
5319†	C.189161/101	Pipe, return, tee-piece to tee-piece	1	DTD.323	C.	
	† C.189161/103	Pipe, undercarriage up, union to union	1	DTD.323	—	
5320†	C.189161/104	Pipe, undercarriage up, sequence valve to pressure regulator valve	1	DTD.323	C.	
5321†	C.189161/105	Pipe, undercarriage up, pressure regulator valve to union	1	DTD.323	C.	
5454†	C.189161/106	Pipe, undercarriage up, union to union	1	DTD.323	—	
5322†	C.189161/107	Pipe, aileron power assisted, tee piece to union	1	DTD.323	C.	
	F.249421/108	Pipe, aileron power assisted, union to union	1	DTD.743	—	
5323†	C.189161/109	Pipe, aileron power assisted, union to union	1	DTD.323	C.	
5456†	C.189161/110	Pipe, aileron power assisted, union to union	1	DTD.323	—	
5324†	C.189161/111	Pipe, aileron power assisted, union to union	1	DTD.323	C.	
5457†	C.189161/112	Pipe, aileron power assisted, union to tee piece	1	DTD.323	—	
	F.249421/113	Pipe, aileron power assisted, tee-piece to jack lock	1	DTD.743	C.	
5458†	C.189161/114	Pipe, return, flexible hose to union	1	DTD.323	—	
5326†	C.189161/115	Pipe, return, union to union	1	DTD.323	C.	
5459†	C.189161/116	Pipe, return, union to union	1	DTD.323	—	
5327†	C.189161/117	Pipe, return, union to union	1	DTD.323	C.	
5328†	C.189161/118	Pipe, return, union to union	1	DTD.323	C.	
5329†	C.189161/119	Pipe, return, union to tee-piece	1	DTD.323	C.	
7089†	C.189161/124-S1	Pipe, pressure, tee-piece to accumulator (Ae.A.T-7222)	1	Stahl	MR/C	

† For details see Piping Chart

SERVICES—HYDRAULICS IN WINGS

Ref. No.	Part No.	Description	No. Off	Material Specification	M.R. Class of Score	Place No.
4575†	C.189161/126	Pipe, flap balance, tee piece to jack up connection...	1	DTD.323	C.	
4577†	C.189161/127	Pipe, flap balance, tee piece to selector	1	DTD.323	C.	
4574†	C.189161/138	Pipe, flap balance, union to flap down connection...	1	DTD.323	C.	
5240†	C.189161/139	Pipe, flap balance, union to union (Mod. 30) ...	1	DTD.323	C.	
5241†	C.189161/140	Pipe, flap balance, selector to union (Mod. 30) ...	1	DTD.323	C.	
5242†	C.189161/141	Pipe, flap balance, tee piece to union (Mod. 30) ...	1	DTD.323	C.	
5332†	C.189161/153	Pipe, undercarriage air, non-return valve to 4-way piece	1	DTD.323	C.	
5333†	C.189161/154	Pipe, undercarriage down, undercarriage jack to 4-way piece	1	DTD.323	C.	
5335†	C.189161/164	Pipe, undercarriage up, tee piece to tee piece ...	1	DTD.323	C.	
5336†	C.189161/165	Pipe, undercarriage up, tee piece to thermal relief valve	1	DTD.323	C.	
5465†	C.189161/167	Pipe, undercarriage up, tee piece to union	1	DTD.323	—	
5338†	C.189161/169	Pipe, undercarriage, jettison valve to tee piece ...	1	DTD.323	C.	
	F.249421/170	Pipe, undercarriage down, union to tee piece ...	1	DTD.743	—	
5467†	C.189161/171	Pipe, undercarriage down, starboard wing break to union	1	DTD.323	—	
5468†	C.189161/174	Pipe, undercarriage down, tee piece to union ...	1	DTD.323	—	
5469†	C.189161/175	Pipe, undercarriage down, union to starboard wing break	1	DTD.323	—	
5470†	C.189161/176	Pipe, undercarriage down, 4-way piece to union ...	1	DTD.323	—	
5339†	C.189161/179	Pipe, power assisted aileron, aileron control valve to tee piece	1	DTD.323	C.	
5340†	C.189161/180	Pipe, power assisted aileron, tee piece to union ...	1	DTD.323	C.	
5341†	C.189161/181	Pipe, undercarriage up, tee piece to sequence valve	1	DTD.323	C.	
5473†	C.189161/182	Pipe, undercarriage air, union to pressure release valve	1	DTD.323	—	
5474†	C.189161/183	Pipe, undercarriage air, non-return valve to pressure release valve	1	DTD.323	—	
Ae. A. Hu-FF-593b	C.189161/185-S1	Pipe, flap up, bleed adaptor to flap jack	1	Stahl	C.	
	C.189161/186-S1	Pipe, flap down, bleed adaptor to flap jack	1	Stahl	C.	
5344†	C.189161/188	Pipe, pressure, tee piece to aileron control valve ...	1	DTD.323	C.	
5220†	C.189161/191	Pipe, undercarriage up, restrictor valve to undercarriage jack	1	DTD.323	C.	
5290†	C.189161/213	Pipe, undercarriage down, starboard wing, undercarriage control valve to tee piece	1	DTD.323	C.	
5752†	C.189161/214	Pipe, undercarriage down, starboard wing, tee piece to shuttle valve	1	DTD.323	—	
5291†	C.189161/215	Pipe, undercarriage down, starboard wing, shuttle valve to tee piece	1	DTD.323	C.	
5753†	C.189161/216	Pipe, undercarriage down, starboard wing, tee piece to union	1	DTD.323	—	
5757†	C.189161/220	Pipe, flap balance, starboard wing break, union to tee piece	1	DTD.323	—	
5758†	C.189161/221	Pipe, flap balance, union to wing break	1	DTD.323	—	
8208†	C.189161/230	Pipe, pressure, tee piece to tee piece (Mod. 265) ...	1	DTD.323	MR/C	
8209†	C.189161/231	Pipe, pressure, starboard wing, tee piece to thermal relief valve (Mod. 265)	1	DTD.323	MR/C	
6994†	C.189161/232	Pipe, return, starboard wing, tee piece to 4-way piece (Mod. 265)	1	DTD.323	C.	
8211†	C.189161/234	Pipe, return, starboard wing, non-return valve to 4-piece (Mod. 265)	1	DTD.323	MR/C	
6993†	C.189161/236	Pipe, undercarriage up, union to jettison valve (Mod. 265)	1	DTD.323	C.	
8086†	C.189161/244	Pipe, air charging, accumulator to tee piece (Mod. 330)	1	DTD.323	C.	
8087†	C.189161/245	Pipe, air charging, tee piece to charging connection (Mod. 330)	1	DTD.323	C.	

† For details see Piping Chart

SERVICES—HYDRAULICS IN WINGS

Ref. No.	Part No.	Description	No. Off					Material Specification	M.R. Class of Store	Plate No.	
			1	2	3	4	5				
8088†	C.189161/246	Pipe, air charging, tee piece to pressure gauge (Mod. 330) ...						1	DTD.323	C.	
†	C.189161/248	Pipe, recuperator, union to union (Mod. 197) ...						1	DTD.323		
†	C.189161/249	Pipe, recuperator, union to tee piece (Mod. 197) ...						1	DTD.323		
†	C.189161/250	Pipe, recuperator, tee piece to leg pivot connection (C) (Mod. 197) ...						1	DTD.323		
†	C.189161/251	Pipe, recuperator, tee piece to P.R.Valve (Mod. 197) ...						1	DTD.323		
†	C.189161/252	Pipe, recuperator, P.R. Valve to tee piece (Mod. 197) ...						1	DTD.323		
†	C.189161/253	Pipe, pressure, union to tee piece (Mod. 197) ...						1	DTD.323		
†	C.189161/254	Pipe, pressure, tee piece to N.R.V. (Mod. 197) ...						1	DTD.323		
†	C.189161/255	Pipe, wheel brake, leg pivot connection (A) to adaptor (Mod. 197) ...						1	DTD.323		
†	C.189161/256	Pipe, wheel brake, adaptor to union (Mod. 197) ...						1	DTD.323		
†	C.189161/257	Pipe, return leg, pivot connection (B) to tee piece (Mod. 197) ...						1	DTD.323		
†	C.189161/259	Pipe, recuperator, tee piece to P.R.V. (Mod. 197) ...						1	DTD.323		
†	C.189161/267	Pipe, pressure, N.R.V. to filter (inlet) (Mod. 486) ...						1	DTD.323		
†	C.189161/268	Pipe, pressure, filter (outlet) to tee piece (Mod. 486) ...						1	DTD.323		
†	C.189161/273	Pipe, return, 4-way piece to tee piece (Mod. 197) ...						1	DTD.323		
†	C.189161/274	Pipe, undercarriage up, 4-way piece to union (Mod. 486) ...						1	DTD.323		
†	C.189161/275	Pipe, undercarriage up, union to jettison valve (Mod. 486) ...						1	DTD.323		
†	C.189161/276	Pipe, oil jettison, jettison valve to atmosphere (Mod. 486) ...						1	DTD.323		
†	C.189161/277	Pipe, undercarriage, air, union to union (Mod. 486) ...						1	DTD.323		
†	C.189161/278	Pipe, undercarriage, air, union to jettison valve (Mod. 486) ...						1	DTD.323		
†	C.189161/279	Pipe, undercarriage, air, jettison valve to shuttle valve (Mod. 486) ...						1	DTD.323		
†	C.189161/280	Pipe, return, 4-way piece to N.R.V. (Mod. 486) ...						1	DTD.323		
†	C.189161/281	Pipe, undercarriage down, sequence valve to union (Mod. 486) ...						1	DTD.323		
	Dowty-O4862Y. BO 7	Regulator, undercarriage pressure (AS.830/56) ...						1	—	A.	
27Q/1224	Dowty-D.6207Y.	Restrictor, one-way (Pre Mod. 753) ...						2	—	A.	
27Q/1975	Dowty-06207-Y.301	Restrictor, one-way (Mod. 753) ...						2	—	A.	
	B.203004	Rod, spacer, group Consisting of:—						2	—		
4131	F.197484	Block, clamp ...						4	LFS.21	C.	NH.1
	AGS.2002/C1	Nut ...						2	—	C.	
	SP 90/C7	Pin, split ...						6	—	C.	
	B.203004/1	Rod, 3/8" dia. × 44" long ...						1	DTD.364		
	SP 900/19	Ring, "O" type ...						4	—	C.	
	STD 1509/23/050	Tube, distance (Make from 30B/1784) ...						6	T.4	—	
	SP 15/C	Washer ...						2	—	C.	
	B.203005	Rod, spacer, group Consisting of:—						2	—		
4131	F.197484	Block, clamp ...						3	LFS.21	C.	
	AGS 2002/C1	Nut ...						2	—	C.	
	SP 90/C7	Pin, split ...						4	—	C.	
	B.203005/1	Rod, 3/8" dia. × 37-70" long ...						1	DTD.364		
	SP 900/19	Ring, "O" type ...						3	—	C.	
	STD 1509/23/050	Tube, distance (Make from 30B/1784) ...						4	T.4	—	
	SP 15/C	Washer ...						2	—	C.	

† For details see Piping Chart

SERVICES—HYDRAULICS IN WINGS

Ref. No.	Part No.	Description	No. Off					Material Specification	M.R. Class of Store	Plate No.	
			1	2	3	4	5				
1932	F.194934	Tee piece, $\frac{1}{2}$ " x $\frac{1}{2}$ " x $\frac{1}{2}$ "						2	LA	C.	
5161	F.199039	Tee piece, $\frac{1}{2}$ " x $\frac{3}{8}$ " x $\frac{3}{8}$ "						2	LA	C.	NH.1
	STD 1509/23/025	Tube, distance, $\frac{3}{8}$ " o/d x 17 S.W.G. (Make from 30B/1784)						1	T.4	MR/C	4
	STD 1507/2/150	Tube, distance (Make from 30A/959)						4	T.26	—	
	STD 1509/12/050	Tube, distance (Make from 30B/1804)						1	T.4	—	4
	STD 1509/12/050	Tube, distance (Make from 30B/1804)						3	T.4	MR/C	4
869	F.140778	Union, reducing						4	L.1	C.	
	Dowty— 08808.Y.BO.2	Unit, control, aileron						1	—	A.	
	Dowty— 08817Y.AO.5	Unit, control, selector flaps						1	—	A.	
	Dowty— 08817Y.AO.6	Unit, control, undercarriage						1	—	A.	
5482	F.202794	Valve, charging						1	—	MR/B	NH.1
27Q/1443	Dowty-D.5212Y	Valve, non-return (Mod. 396)						2	—	A.	
27Q/926	Dowty— D.5220Y	Valve, non-return						3	—	A.	
27Q/930	Dowty— 1.00051.034	Valve, flap pressure relief						1	—	A.	
27Q/1999	Dowty— O.8950Y.BO.3	Valve, sequence, undercarriage, port (AS.770/64)						1	—	A.	
27Q/2000	Dowty— O.8950Y.BO.4	Valve, sequence, undercarriage, starboard (AS.770/64)						1	—	A.	
27Q/945	Dowty— C.4122Y.Mk. A	Valve, shuttle undercarriage						1	—	A.	
27Q/927	Dowty— C.4603Y.Mk. A	Valve, thermal relief						6	—	A.	
27Q/1205	Dowty— D.7523Y	Valve, throttling						1	—	A.	
27Q/845	Dowty-C.3651Y	Valve, pressure regulator						2	—	A.	
	Dowty— 04862Y.BO.8	Valve, flap pressure regulator (AS.830/56)						1	—	A.	
27Q/1034	Dowty-D.4930Y	Valve, selector (pressure relief)						2	—	A.	
27Q/1221	Dowty-D.7375Y	Valve, sequence (emergency air)						2	—	A.	
27Q/1223	Dowty— C.7596Y.Mk. B	Valve, sequence, port						1	—	A.	
	oder Dowty— 1.00043.012										
27Q/1817	Dowty C.7596Y.Mk. C	Valve, sequence, starboard						1	—	A.	
	oder Dowty— 1.00043.013										
27Q/1204	Dowty— C.4122Y.Mk. G	Valve, shuttle						1	—	A.	
27Q/1198	Dowty— C.2701Y.Mk. H	Valve, jettison						2	—	A.	
27Q/1381	Dowty— C.4809Y.Mk. B	Valve, reducing with integral P.R. valve (Mod. 197) 1						1	—	A.	
5162	F.202820	Washer, for sequence valve 1 mm						4	—	C.	NH.1
	STD 1208/100/ 49/10	Shim, for sequence valve adjustment, 0,3 mm						QR	Steel	C	NH.1

SERVICES—HYDRAULICS IN WINGS

Ref. No.	Part No.	Description	No. Off	Material Specification	M.R. Class of Score	Plate No.
	C.208007	WING FUSELAGE CONNECTIONS ASSEMBLY	-	-		
2081	F.195583	Block, clamp, on port side of diaphragm G ...	2	LFS.21	C.	
2100	F.195658	Block, clamp, between diaphragm, "G" and wing rib "A"	1	LFS.21	C.	
2101	F.195659	Block, clamp, between diaphragm "G" and wing rib "A"	1	LFS.21	C.	
2102	F.195660	Block, clamp, between diaphragm, "G" and wing rib "A"	1	LFS.21	C.	
8307	F.215473	Block, clamp, starboard diaphragm "G" (Mod. 197)	1	LFS.21	C.	
8308	F.215474	Block, clamp, starboard diaphragm "G" (Mod. 197)	1	LFS.21	C.	
	Std.840/12	Clip, $\frac{1}{8}$ " wide x 22 S.W.G. x 1-2" long ...	1	DTD.610		
3698†	C.189160/28	Pipe, wheel brake, port wing break, union to union	1	DTD.323	—	
	F.24942035	Pipe, power assisted aileron, port wing break, union to union	1	DTD.743	—	
3717†	C.189160/59	Pipe, flap air, port wing break, union to union	1	DTD.323	—	
5441†	C.189160/158	Pipe, pressure, elbow to union ...	1	DTD.323	—	
5445†	C.189160/162	Pipe, undercarriage air, port wing break, union to union	1	DTD.323	—	
5448†	C.189160/166	Pipe, return, port wing break to tee piece ...	1	DTD.323	—	
7107†	C.189160/201	Pipe, undercarriage up, union to elbow at port wing break	1	DTD.323	MR/C	
7108†	C.189160/202	Pipe, undercarriage up, union to port wing break	1	DTD.323	MR/C	
	† C.189160/223	Pipe, recuperator, union to union (Mod. 197) ...	1	DTD.323		
3415†	C.189161/1	Pipe, pressure, starboard wing break to union ...	1	DTD.323		
3426	C.189161/12	Pipe, return, starboard wing break to tee piece ...	1	DTD.323	C.	
3447†	C.189161/33	Pipe, undercarriage up, union to starboard wing break	1	DTD.323	—	
3454†	C.189161/40	Pipe, undercarriage up, union to starboard wing break	1	DTD.323	C.	
3467†	C.189161/53	Pipe, undercarriage down, union to starboard wing break	1	DTD.323	—	
3473†	C.189161/59	Pipe, wheel brake, starboard wing break to union	1	DTD.323	—	
5316†	C.189161/90	Pipe, undercarriage air tee piece to starboard wing break	1	DTD.323	C.	
5477†	C.189161/189	Pipe, undercarriage air, starboard wing break to union	1	DTD.323	—	
5345†	C.189161/190	Pipe, undercarriage air tee piece to tee piece ...	1	DTD.323	C.	
5754†	C.189161/217	Pipe, power assisted aileron union to starboard wing break	1	DTD.323	—	
5755†	C.189161/218	Pipe, undercarriage air union to tee piece ...	1	DTD.323	—	
	† C.189161/247	Pipe, recuperator, union to union (Mod. 197) ...	1	DTD.323	—	

† For details see Piping Chart

SERVICES—HYDRAULICS IN WINGS

Ref. No.	Part No.	Description					No. Off	Material Specification	M.R. Class of Store	Plate No.
		1	2	3	4	5				
		<u>Quersteuer-Servodyne im Flügel Li./re.</u>								
Ae.A. Hu-FT-535	Auto,Prod.- AVA.322 BX/22,5-S1					Flex-Teflonleitung	2			
F+W Pkt.336	Auto:Prod.— AVA.322 AX/22,5-S1					Flex-Teflonleitung	2			
Ae.A. 1233	6F-F+W-516267					Klemmbride komplett	2			
	A 25/6C					6 kt.-Schraube	4			
	A 25/13C					6 kt.-Schraube	6			

SERVICES—HYDRAULICS IN WINGS

Ref. No.	Part No.	Description					No. Off	Material Specification	M.R. Class of Store	Plate No.
		1	2	3	4	5				
SUMMARY OF STOCK ITEMS										
	AGS.1212	Adaptor	—	—	—
	AGS.1129B	Body, banjo	—	—	—
	A25.1.B	Bolt, 4 B.A.	—	—	—
	A25.2.B	Bolt, 4 B.A.	—	—	—
	A25.3.B	Bolt, 4 B.A.	—	—	—
	A25.4.B	Bolt, 4 B.A.	—	—	—
	A25.5.B	Bolt, 4 B.A.	—	—	—
	A25.7.B	Bolt, 4 B.A.	—	—	—
	A25.7.B	Bolt, 4 B.A.	—	—	—
	A25.8.B	Bolt, 4 B.A.	—	—	—
	A25.9.B	Bolt, 4 B.A.	—	—	—
	A25.10.B	Bolt, 4 B.A.	—	—	—
	A25.11.B	Bolt, 4 B.A.	—	—	—
	A25.12.B	Bolt, 4 B.A.	—	—	—
	A25.13.B	Bolt, 4 B.A.	—	—	—
	A25.16.B	Bolt, 4 B.A.	—	—	—
	A25.1.C	Bolt, 2 B.A.	—	—	—
	A25.3.C	Bolt, 2 B.A.	—	—	—
	A25.5.C	Bolt, 2 B.A.	—	—	—
	A25.6.C	Bolt, 2 B.A.	—	—	—
	A25.7.C	Bolt, 2 B.A.	—	—	—
	A25.8.C	Bolt, 2 B.A.	—	—	—
	A25.9.C	Bolt, 2 B.A.	—	—	—
	A25.10.C	Bolt, 2 B.A.	—	—	—
	A25.11.C	Bolt, 2 B.A.	—	—	—
	A25.13.C	Bolt, 2 B.A.	—	—	—
	A24.14.C	Bolt, 2 B.A.	—	—	—
	A25.15.C	Bolt, 2 B.A.	—	—	—
	A26.16.C	Bolt, 2 B.A.	—	—	—
	A25.18.C	Bolt, 2 B.A.	—	—	—
	A25.19.C	Bolt, 2 B.A.	—	—	—
	A25.20.C	Bolt, 2 B.A.	—	—	—
	A25.15.E	Bolt, 1/2" B.S.F.	—	—	—
	AS.5419/3	Clip	—	—	—
	AS.5419/4	Clip	—	—	—
	AS.5419/5	Clip	—	—	—
	AGS.1159/A	Cap, cone	—	—	—
	AGS.1159/B	Cap, cone	—	—	—
	AGS.1120/1	Cone, tee	—	—	—
	AGS.1120/3	Cone, tee	—	—	—
	AGS.1120/6	Cone, tee	—	—	—
	AGS.1120/11	Cone, tee	—	—	—
	AGS.1118/C	Cone, tee	—	—	—
	AGS.1118/B	Cone, tee	—	—	—
	AGS.1118/A	Cone, tee	—	—	—
	AGS.1116/B	Cone, elbow	—	—	—
	AGS.1116/C	Cone, elbow	—	—	—

SERVICES—HYDRAULICS IN WINGS

Ref. No.	Part No.	Description					No. Off	Material Specification	M.R. Class of Store	Plate No.
		1	2	3	4	5				
SUMMARY OF STOCK ITEMS (continued)										
AGS.1200		Connector, charging	—	—	—
AS.3360.B3.B		Lead, bonding	—	—	—
AGS.1142/A		Nipple	—	—	—
AGS.1170/A		Nipple	—	—	—
AGS.1170/B		Nipple	—	—	—
AGS.1170/C		Nipple	—	—	—
AGS.1170/D		Nipple	—	—	—
A27.C.T.		Nut	—	—	—
AGS.2002/B1		Nut, 4 B.A.	—	—	—
AGS.2002/C1		Nut, 2 B.A.	—	—	—
AGS.2002/E1		Nut, 1/2" B.S.F.	—	—	—
AGS.1174		Screw, bleed	—	—	—
AGS.904/A		Sleeve	—	—	—
AGS.904/B		Sleeve	—	—	—
AGS.1106/B		Union, cone to nipple	—	—	—
AGS.1113/A		Union, bulkhead	—	—	—
AGS.1113/B		Union, bulkhead	—	—	—
AGS.1125/1		Union, tee 4-way	—	—	—
AGS.1123/C		Union, cone 4-way	—	—	—
AGS.1107A		Union, reducing	—	—	—
A31.B32		Screw	—	—	—
A32.B14		Screw	—	—	—
A32.B24		Screw	—	—	—
SP.15.B		Washer, 4 B.A....	—	—	—
SP.15.C		Washer, 2 B.A....	—	—	—
SP.15.E		Washer, 1/2" dia.	—	—	—
SP.16.C		Washer, 2 B.A....	—	—	—
SP.16.B		Washer	—	—	—
AGS.1138B		Washer	—	—	—
AGS.1186B		Washer	—	—	—

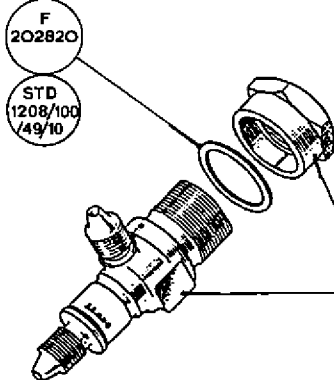
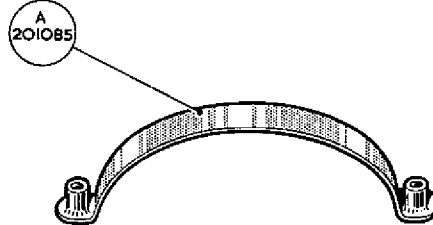
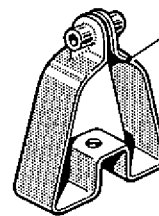
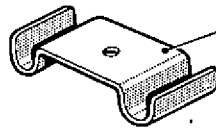
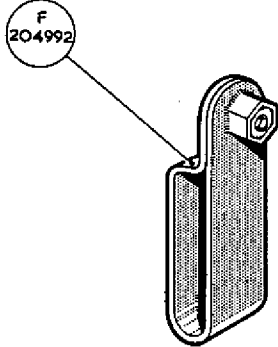
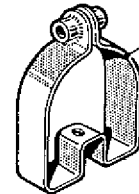
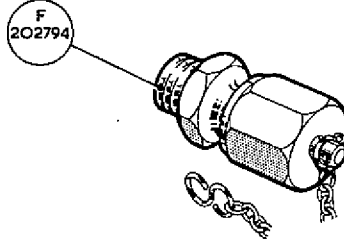
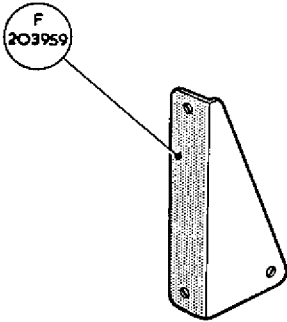
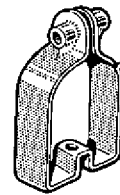
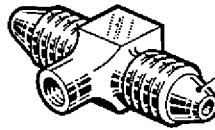
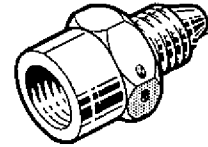
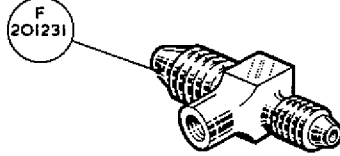
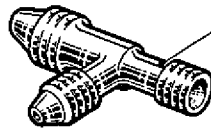
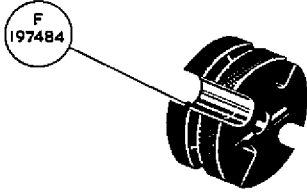

STD
1208/100
/49/10

Dowly
D.7375
Y

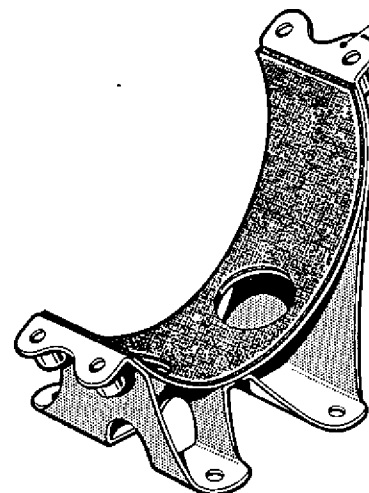

This file was downloaded
from the RTFM Library.

Link: www.scottbouch.com/rtfm

Please see site for usage terms,
and more aircraft documents.

