

Chapter 4

LIGHTNING F MK 3

LIST OF LETTERED ADDENDA
(EJECTION SEAT MK. 4BSC)

Mod No.

Addendum

2690

*Introduction of downward pull
negative-G restraint strap*

A

RESTRICTED

Chapter 4

LIGHTNING F MK.3

LIST OF CONTENTS

	Para.		Para.
Introduction ..	1	Equipping the seat	15
Composition of the assembly ..	2	Strapping-in procedure ..	17
The Type 4 BSC ejection seat and associated equipment	3	Emergencies	18
Connections to the aircraft	14	Leaving the aircraft after landing	19

LIST OF ILLUSTRATIONS

	Fig.		Fig.
Arrangement of oxygen supply on seat	1	The seat equipped (2)	5.
Arrangement of drogue withdrawal and link lines	2	Arrangement of leg restraint cords ..	6
Arrangement of negative 'G' restraining strap on P.S.P ..	3	Arrangement of negative 'G' restraining strap to lap straps	7
The seat equipped (1) ..	4	The seat occupied (1)	8
		The seat occupied (2) ..	9

LIST OF APPENDICES

	App.
Flying clothing . . .	1
◀ Type 4 BSC Mk.2 ejection seat ..	2 ▶

Introduction

1 This chapter is primarily concerned with installation of equipment in or on the seat, preparation by the pilot for flying (dressing and functional testing of the flying clothing), strapping-in procedure and the drill to be used when leaving the aircraft after landing. A brief description of the various components of the aircrew equipment assembly is included, full details will be found in the appropriate publication, a reference to which is contained in para.14 and Appendix 1.

COMPOSITION OF THE ASSEMBLY

2. The aircrew equipment assembly for this aircraft consists of the following items:—

Ejection seat	◀ Type 4 BSC ▶
Parachute assembly	Back Type, Mk.28
Personal survival pack	Type V (c/w cushion)
Emergency oxygen set	Cylinder and release mechanism Mk.1 Demand E.O. regulator Mk.1
Flying clothing assembly	Refer to App.1

The Type 4 BSC ejection seat and associated equipment

3. The Mk. 4 BSC seat is ejected from the aircraft by a cartridge-operated gun and may be used for low level ejection in accordance with the instructions on the side of the drogue con-

tainer, provided the air speed is over 90 kt. and the aircraft flight path is straight and level. During ejection, the seat slides in two guide rails attached to the cylinder tube of the ejection gun, the rails are fitted with brackets which enable the gun to be bolted to the airframe structure.

4. The back type Mk.28 parachute assembly incorporates a combined safety/parachute harness, the pack is housed in a container which forms an integral part of the seat and the harness is attached to the seat by lugs at three quick-release points, one under the support bracket for the parachute pack and two at the back of the seat pan. These lugs may be separated from the seat by the action of a barostatic time-release unit or by a manual separation lever on the port side of the seat pan to the rear. Forward on the port side of the seat pan is a "go-forward" lever which, when the knob is pushed forward, releases the snub lever and allows the occupant to lean forward in the cockpit without separating the parachute assembly from its attachment points, forward movement is only possible when the lever is held forward against the spring. When the lever is released, the occupant may maintain the forward position of the body but, on returning to the upright position, the spring will take up the slack and the snub lever will lock the system against renewed forward movement.

5. Housed in the seat pan is the Type V personal survival pack (P.S.P.) which, with the cushion, forms a comfortable seat for the occupant. The pack is attached to the combined harness by side quick-release couplings and its lowering line is connected to the flying clothing during strapping-in. A negative-G restraining strap is fitted over the pack between the bottom harness locks and an anchor bracket on the inside of the seat pan behind the alternative firing handle. This strap extends upwards from the bracket to the lap straps and when tightened prevents forward movement of the pack, cushion and occupant.

6. An emergency supply of oxygen is carried in a cylinder clamped to the starboard side of the seat at the rear; the supply is turned on

automatically during ejection, but provision is also made for manual operation in the event of failure of the main oxygen supply

7. A personal equipment connector (P.E.C.) is fitted to the starboard side of the seat pan, enabling the main and emergency oxygen, air-ventilated suit, anti-G suit and Mic/Tel services to be connected, or disconnected, in one action. A complete description of the P.E.C. will be found in Sect.1, Chap.5. The connector consists of the following items:—

- (1) *The aircraft component.* Connected to the cockpit floor by a static line, and to aircraft services for main oxygen A.V.S., anti-G and Mic/Tel systems.
- (2) *The seat component.* Bolted to the seat pan and connected to the emergency oxygen set.
- (3) *The personal component.* Attached to the jerkin and oxygen assemblies.

8. Two firing handles are fitted to the seat. The main handle, which has an integral face screen, projects from the front of the drogue container; the alternative handle is partly recessed into the top front edge of the seat pan and is intended for use only when the occupant is unable to reach the main handle, e.g., when subjected to high 'G' forces. Both handles are connected to the hood jettison mechanism and when either handle is pulled the hood is jettisoned immediately, the seat being ejected after a delay of one second. A restrictor is fitted to the hood jettison firing unit to prevent operation of the ejection gun until the hood has been jettisoned. A separate hood jettison handle is also provided to enable the hood to be jettisoned without ejection taking place.

9. Leg restraint cords, fitted through snubbing units under the seat pan, ensure that the occupant's legs are drawn back to the seat pan and restrained there during ejection, thereby reducing the risk of injury. An interconnection between the leg restraint cords and the P.E.C. ensure that the cords cannot be connected until the personal component of the P.E.C. is correctly engaged with and locked to the seat component.

- (2) Remove and retain the safety pin from the emergency oxygen cylinder operating head.
- (3) Ensure that the leg restraint cords are clear of the seat and that the seat pan is clean.
- (4) Place the parachute pack on its support bracket temporarily and ensure that the pack restraining straps and headrest cushion are immediately available.
- (5) Ensure that the harness straps are not twisted. Operate the harness 'go-forward' lever, pull out the strap under the support bracket and pass it ◀ downward ▶ through the D-shackle.
- (6) Lift the parachute pack forward (this may be done before pulling out the centre strap if more convenient), pass each pack restraining strap O-ring over the centre strap lug and insert the lug into the attachment point below the bracket. Pull sharply on the harness to ensure that the lug is locked securely
- (7) Pass the pack restraining straps through the arch of the pack, replace the pack on its support bracket and ensure that the restraining straps are not twisted.
- (8) Position the headrest cushion centrally on top of the parachute pack and ensure that it is not inverted.
- (9) Pass the port pack restraining strap through the loop in the drogue link line, through the buckle on the short strap at the port side of the drogue container and then forward through the buckle on the port side of the headrest cushion.
- (10) Pass the starboard pack restraining strap through the buckle on the short strap at the starboard side of the drogue container (refer to the note following sub-para. (9)) then forward through the buckle on the starboard side of the headrest cushion.
- (11) Tighten the pack restraining straps, ensuring that the headrest cushion remains central on top of the parachute pack.
- (12) Connect the two halves of the drogue link line coupling, ensuring that the line passes under the port pack restraining strap and UNDER THE DROGUE WITHDRAWAL LINE.
- (13) Fit the negative-G restraining strap as follows:-
 - (a) With the blue "Y" section removed, pass the buckle end of the white "Y" section through the anchor bracket inside the front of the seat pan from bottom to top. Attach the straight part of the blue "Y" section to the buckle so that the free end is facing forward with the "Y" part uppermost.
 - (b) Place the personal survival pack in the seat pan and route the white "Y" section of the strap over the top of the personal survival pack to the rear bottom harness locks on the seat. Engage the looped ends of the strap over the appropriate bottom lock harness lugs and insert the lugs in the locks. Pull sharply on the harness to ensure that the lugs are securely locked and ensure that the straps lie flat across the pack.
- (14) Fit the cushion to the seat strap of the harness as follows:-
 - (a) Pass the strap under the cushion and locate it in position with the two press-studded beackets.
 - (b) Pass the leather covered straps of the cushion through the webbing loops on either side of the P.S.P from rear to front. Pass the leg

Note

When passing the parachute restraining strap through the buckle on the short strap at the side of the drogue container, ensure that it passes through from the outside inwards.

straps of the combined harness up through the slot in the cushion and secure the cushion to the pack with the lift-the-dot fasteners at the front.

- (c) Pull the negative-G restraining strap forward and upward through the bracket to settle the P.S.P down in the seat pan.
- (15) Connect the side quick-release couplings of the P.S.P to their harness components.
- (16) Insert the harness sticker straps into the spring clips on the inside of the seat pan and ensure that they pass outside the P.S.P side quick-release couplings.
- (17) Place the harness straps in the stowage clips situated immediately below the windscreen arch under the cockpit coaming.
- (18) Ensure that the seat is made safe for parking in accordance with current instructions.

STRAPPING-IN PROCEDURE

17 The procedure for strapping-in is as follows, refer to fig.6 to 9 for detail as necessary:—

- (1) Ensure that the seat is made safe for parking in accordance with current instructions.
- (2) Before entering the seat, ensure that the harness is securely attached to the seat by pulling on the straps, individually, at each attachment point.
- (3) Sit in the seat and adjust its height to approximately the middle position; this enables the alternative firing handle safety pin to be removed at a later stage without fouling the control column.
- (4) Remove the dust cover from the seat

component of the P.E.C. and fit it into its stowage on the right-hand side of the seat pan.

- (5) Fit the personal component of the P E.C. to the seat component and apply pressure under the handle (without touching the release catch) to check that it is securely locked to the seat component.
- (6) Connect the P.S.P lowering line to its corresponding fitting on the pressure jerkin or life-jacket, as appropriate, and ensure that it passes outside the left leg.
- (7) Pass the left-hand leg restraint cord through the right leg garter D-ring and plug it into the socket above the left-hand snubbing unit. Pass the right-hand leg restraint cord through the left leg garter D-ring and plug it into the socket above the right-hand snubbing unit. Pull sharply on each cord to ensure that it is securely locked in its socket (remember that unless the personal component of the P.E.C. is securely fitted to the seat component the leg restraint cords cannot be secured in their sockets). It is not important which cord is secured first so long as the cords are not interlaced.
- (8) Adjust the leg restraint cords in the snubbing unit to obtain the required range of leg movement.

Note . . .

If the cords are too short, pull the ring of each snubbing unit and ease the cords forward; slack can be taken up by pulling the cords backwards through the snubbing units.

- (9) Adjust the parachute back pad and the height of the lumbar cushion. Draw up the blue "Y" section of the negative-G restraining strap and pass the appropriate looped end over each lap strap; ensure that the adjustment buckle and short strap end face forward and that

the 'Y' section lies flat against the inside of the thighs. Connect and tighten the harness lap straps ensuring that the right hand strap passes outside the hoses from the personal component of the P E.C.

Note

- ◀ (1) *When connecting the first lug to the inertia proof quick-release fitting, turn the disc knob anti-clockwise until the yellow line co-incides with dots on the body and insert the lug. The remaining lugs are fitted without further manipulation of the disc knob.*
- (2) *When an inertia proof quick-release fitting is provided, the safety clip mentioned in sub-para. (11) is not required and will have been removed from the harness. ▶*
- (3) *The lap straps must be as tight as possible. To tighten these straps fully, it is necessary to relieve the tension in the 'standing end' of each strap (the ends carrying the buckles) otherwise the buckles become stiff. Pull on the 'running end' with one hand and push the webbing of the 'standing end' towards the buckle with the other; it may be necessary to do this several times before the straps are really tight and while it is being done the occupant should push himself well back into the seat.*
- (10) Pass the left leg loop upwards over the inside of the thigh and through the D-ring on the left leg strap (from the inside of the ring towards the outside of the leg). Bring the end of the leg loop over towards the quick-release fitting, pass the lug of the left shoulder strap through the leg loop (from the top downwards) and insert the lug into its appropriate slot in quick-release fitting; snug the loop down over the lug. Repeat these operations for the right leg loop and shoulder strap.
- (11) Adjust the negative-G restraining strap as tight as possible and tuck the free end back under the elastic

band. Fit the safety clip behind the disc knob of the harness quick-release fitting.

- (12) Remove the safety pin from the alternative firing handle and place it in its stowage on the console.
- (13) Adjust the sitting height to the desired position (ideally the head is to be located centrally against the headrest cushion).
- (14) Ensure that the shoulder straps pass under the folds of the life-jacket or pressure jerkin stole; tighten the inner (BLUE) straps and then the outer (KHAKI) straps.

Note

It is undesirable to tighten these straps excessively since this action may arch the back and produce an unsuitable position for ejection. The inner straps are not to press down on the shoulders appreciably in ordinary conditions; equally there is to be no slack, so that in inverted flight these straps can take some of the weight off the lap straps as the body tends to stretch. The outer straps are to be similarly adjusted to prevent forward movement of the shoulders.

- (15) Ensure that the oxygen supply is connected to the oxygen mask or partial pressure helmet and that chin straps (as appropriate) are securely fastened. Connect the Mic/Tel lead.
- (16) Remove the safety pin from the main firing handle and place it in the stowage on the console (this is normally done by a member of the ground crew; if one is not available, the pilot is to remove and stow the pin prior to strapping-in).

EMERGENCIES

18. Instructions for dealing with emergencies are contained in A.P.4700C-P.N, to which reference is to be made, as necessary

LEAVING THE AIRCRAFT AFTER LANDING

19. The following sequence should be used when leaving the aircraft after landing :-

- (1) Remove the safety pins from their stowage on the console, fit the short pin through the alternative firing handle and hand the others to the ground crew member who will then fit the long pin through the main firing handle lock.

Note .

If a ground crew member is not available, the pilot is to fit the main firing handle safety pin before leaving the cockpit.

- (2) Remove the safety clip from the harness quick-release fitting, operate the fitting, free the harness straps (including the negative-G strap) and

return the fitting to the locked position. Stow the straps on the clips provided in the cockpit.

◀ Note .

When an inertia proof quick-release fitting is provided, a safety clip will not be fitted behind the disc knob. ▶

- (3) Disconnect the personal component of the P E.C. from the seat component; remove the dust cover from its stowage and fit it to the seat component.
- (4) Free the leg restraint cords from the garters.
- (5) Disconnect the P.S.P lowering line from the life-jacket or pressure jerkin, as appropriate.
- (6) Disconnect the Mic/Tel lead.
- (7) Vacate the aircraft.

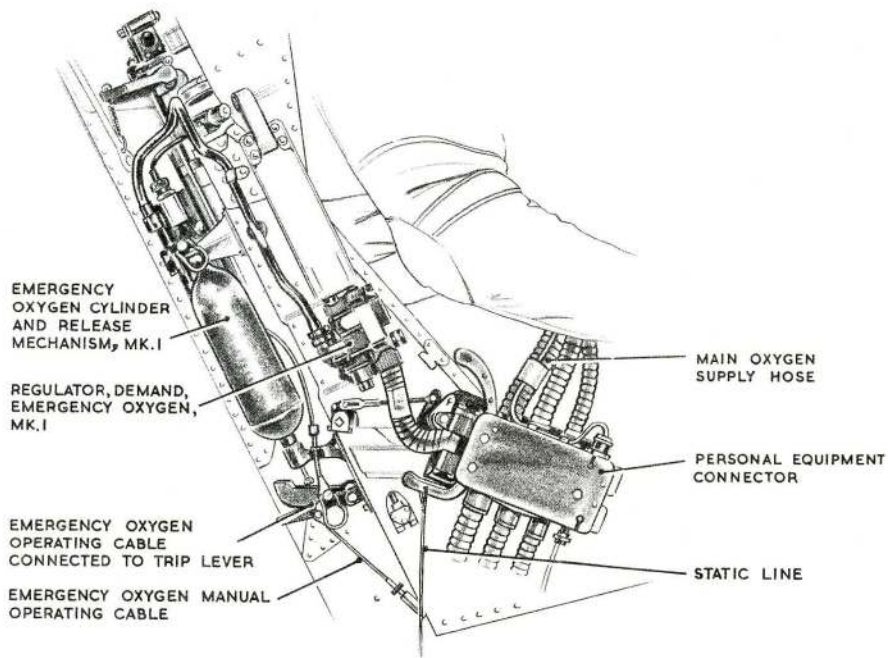

Fig. 1 Arrangement of oxygen supply on seat

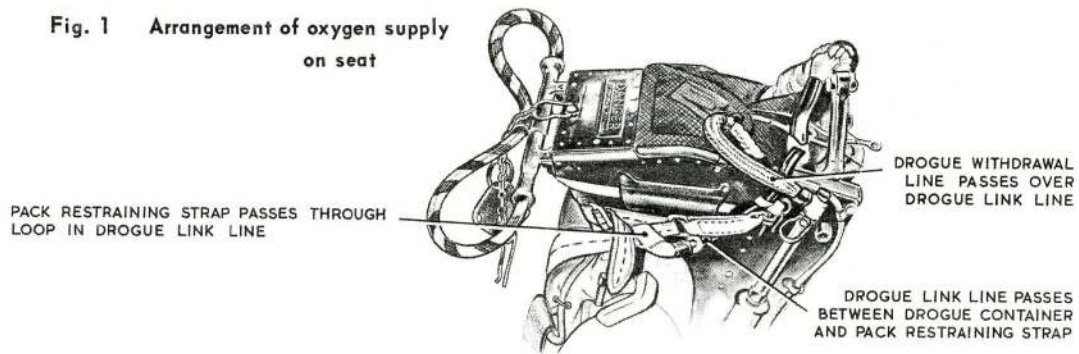

Fig. 2. Arrangement of drogue withdrawal and link lines

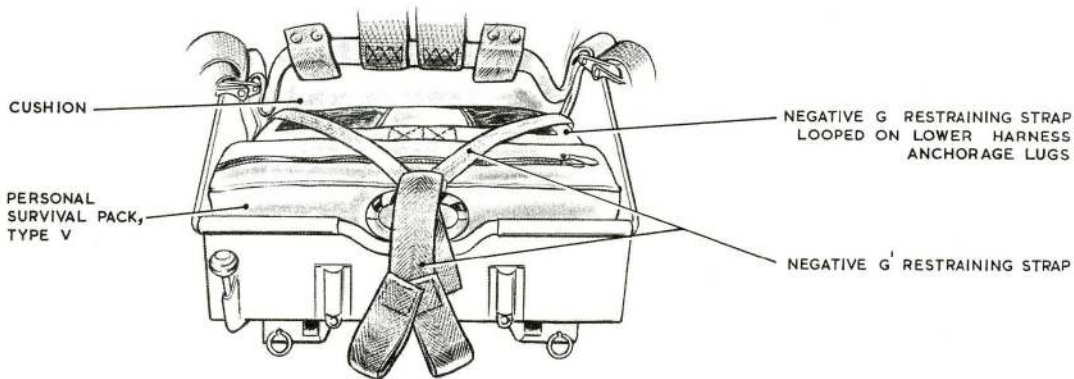

Fig. 3. Arrangement of negative 'G' restraining strap on P.S.P

RESTRICTED

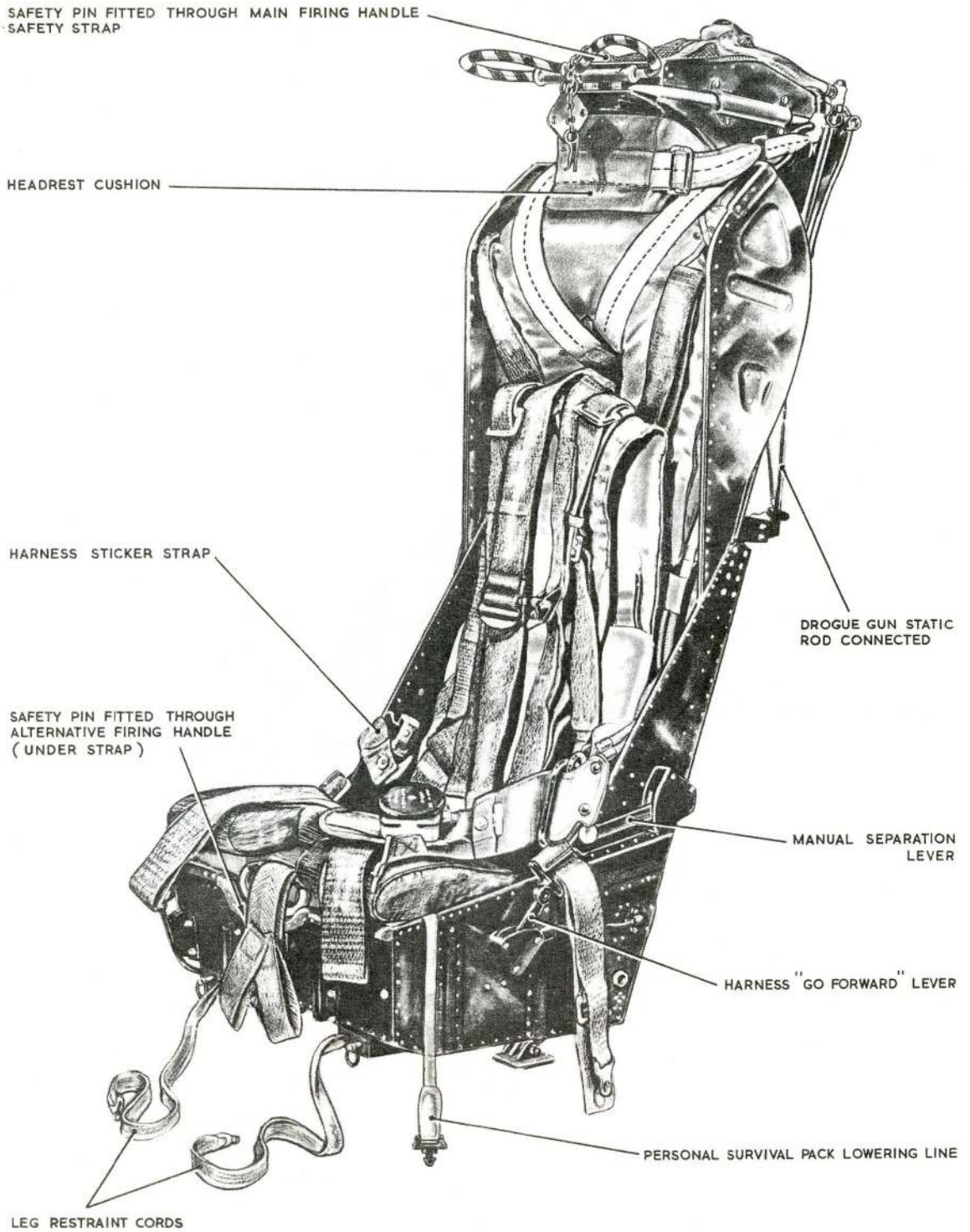

Fig. 4. The seat equipped (1)

RESTRICTED

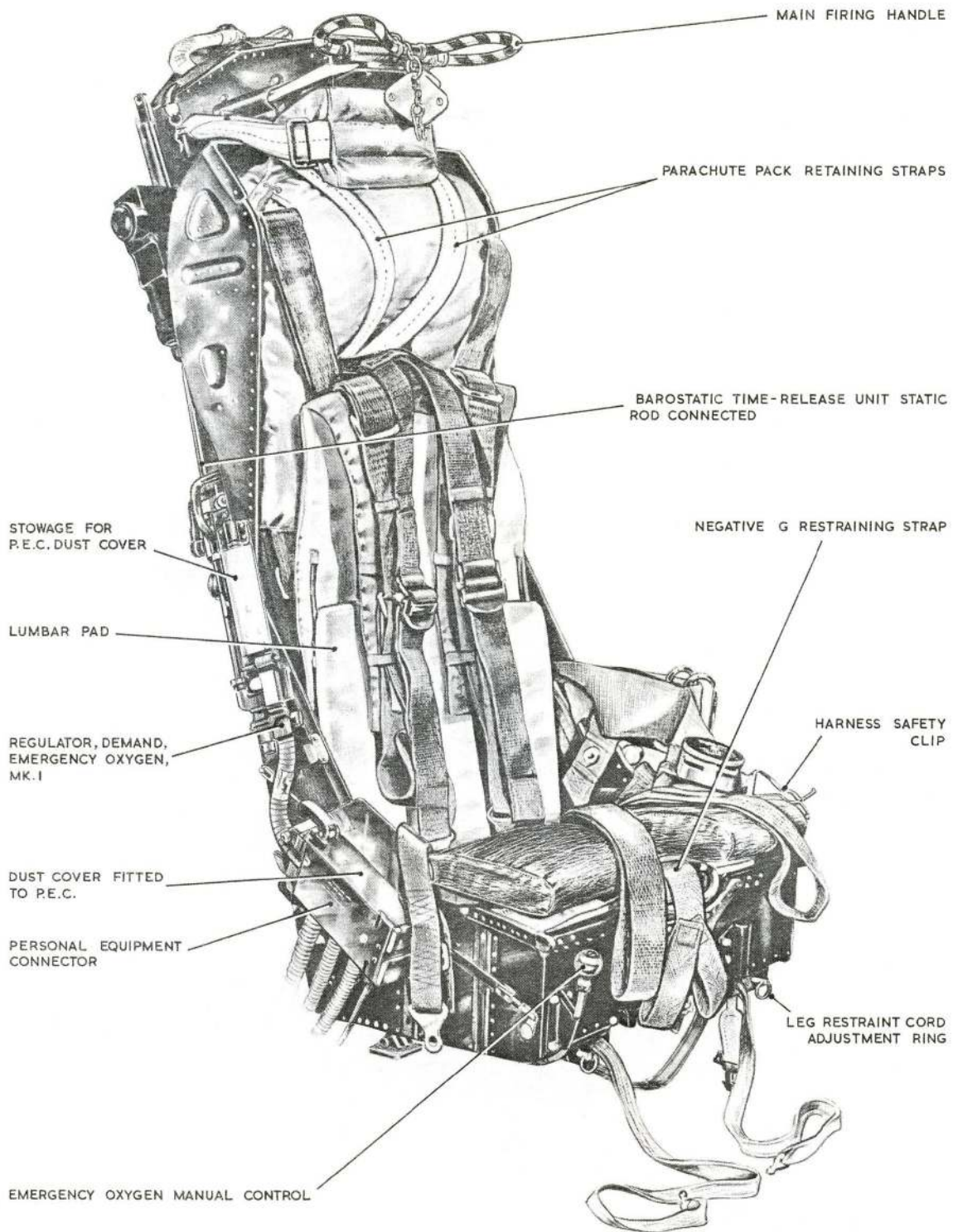

Fig. 5. The seat equipped (2)

RESTRICTED

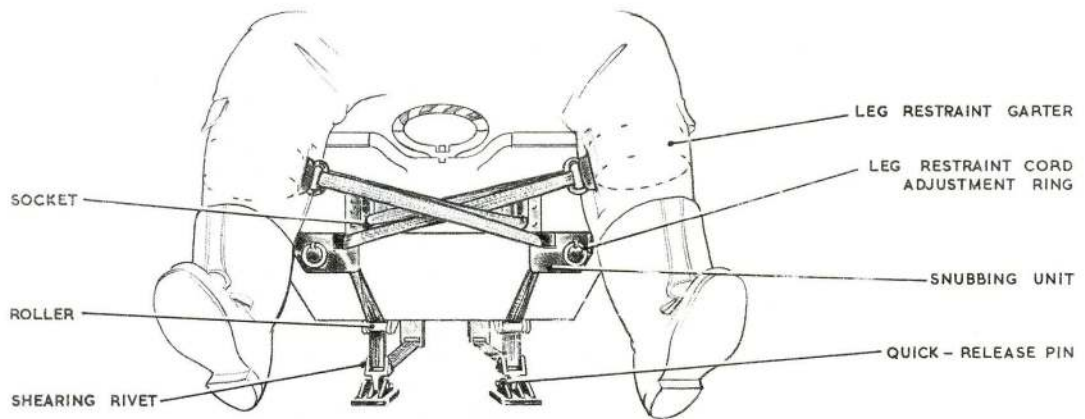

Fig. 6. Arrangement of leg restraint cords

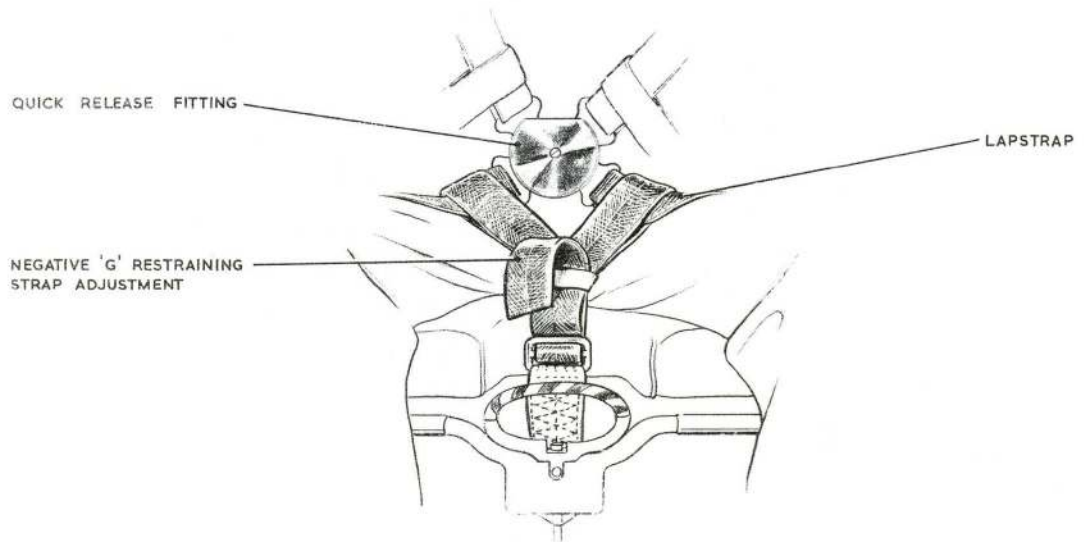

Fig. 7 Arrangement of negative 'G' restraining strap to lap straps

RESTRICTED



Fig. 8. The seat occupied (1)

RESTRICTED



Fig. 9 The seat occupied (2)

RESTRICTED

Addendum A

EJECTION SEAT MK. BSC MOD. NO. 2690

(Introduction of downward pull negative-G restraining strap)

1 Modification E.S. 2690 introduces a downward pull negative-G restraint strap in lieu of the upward pull strap introduced by modification P A.69.

2. When modification 2690 is embodied, the appropriate paragraphs and figures of Chapter 4 should be read as follows:-

(1) Para. 5.

Housed in the seat pan is a Type V personal survival pack, which with the cushion, forms a comfortable seat for the occupant. The pack is attached to the combined harness by side quick-release couplings and its lowering line is connected to the flying clothing during strapping in. A negative-G restraining strap which is tightened by a downward pull (introduced by modification E.S.2690) is fitted underneath the pack, the strap is passed through brackets attached to the floor of the seat pan and anchored to the rear harness attachment lugs and the lap strap lugs which fit into the harness quick-release box. When tightened, the strap restrains the occupant from vertical movement when subjected to high negative-G forces.

(2) Para. 16 (13).

(a) Thread the white straps through the front bracket on the floor of the seat pan from front to rear, ensuring that the yellow tab on the buckle is facing forward. The white straps are marked 'PORT' and 'STAR BOARD' and it is essential that they are so positioned to ensure correct installation.
(b) Pass the straps rearwards and thread each strap through its respective rear bracket in the floor of the seat pan.
(c) Engage the looped end of each strap over its respective bottom lock harness lug and insert the lugs into their respective bottom locks. It may be necessary to partially depress the harness release lever beneath the barostatic time release unit to

facilitate insertion of the lugs. Check that they have locked correctly by pulling on the lugs

(d) Drape the blue 'Y' piece of the negative-G strap OVER THE TOP of the seat pan firing handle

(e) Lift the harness clear of the seat pan and insert the personal survival pack into the pan

(3) Para. 16 (14).

Fit the cushion to the seat strap of the harness as follows:-

(a) Pass the strap under the cushion and locate it in position with the two press-studded buckets.

(b) Pass the leather covered straps of the cushion through the webbing loops on either side of the P.S.P from rear to front. Pass the leg straps of the combined harness up through the slot in the cushion and secure the cushion to the pack with the lift-the-dot fasteners at the front.

(4) Para. 17 (11).

Tighten the negative-G restraint strap by pulling DOWNWARDS on the free end of the blue strap until the strap is as tight as possible and ensure that the free end is then tucked down BEHIND the alternative firing handle. The strap is fitted with a snubber, which is released by pulling downwards on the yellow tab attached to the snubber lever, to loosen the strap.

(5) Fig.3. Arrangement of negative-G restraining strap on P.S.P Disregard Fig. 3 in Chapter 4 and refer to Fig. 1 of this addendum.

Fig.7 Arrangement of negative-G restraining strap to lap straps. Disregard Fig.7 in Chapter 4 and refer to Fig. 2 of this addendum.

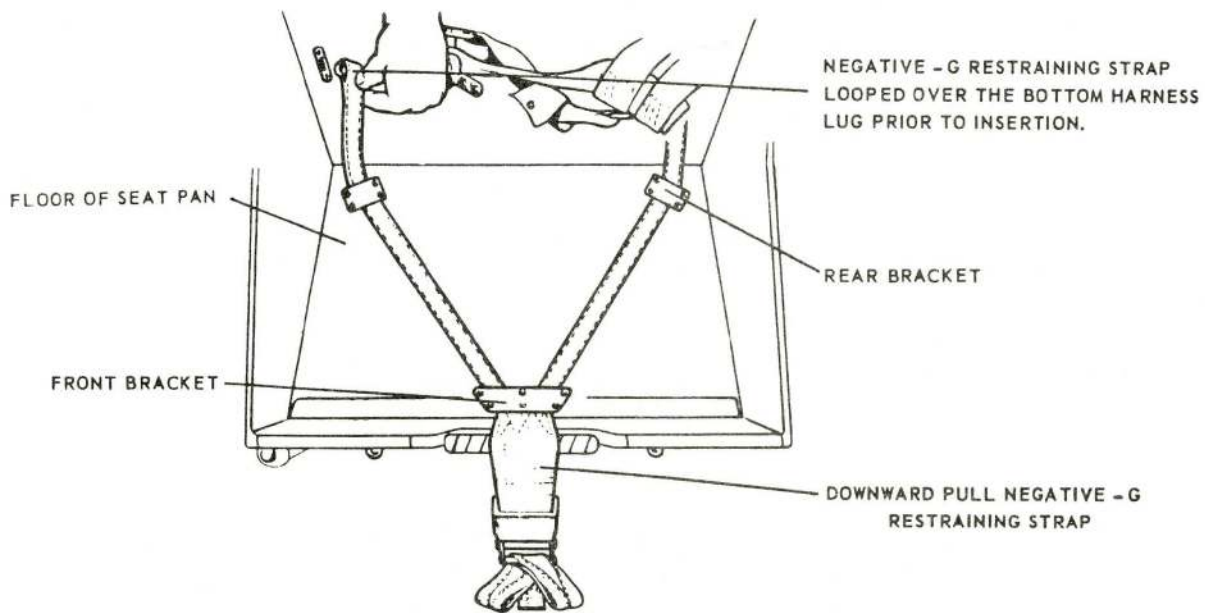

Fig. 1 Arrangement of downward pull negative-G restraining strap in seat pan

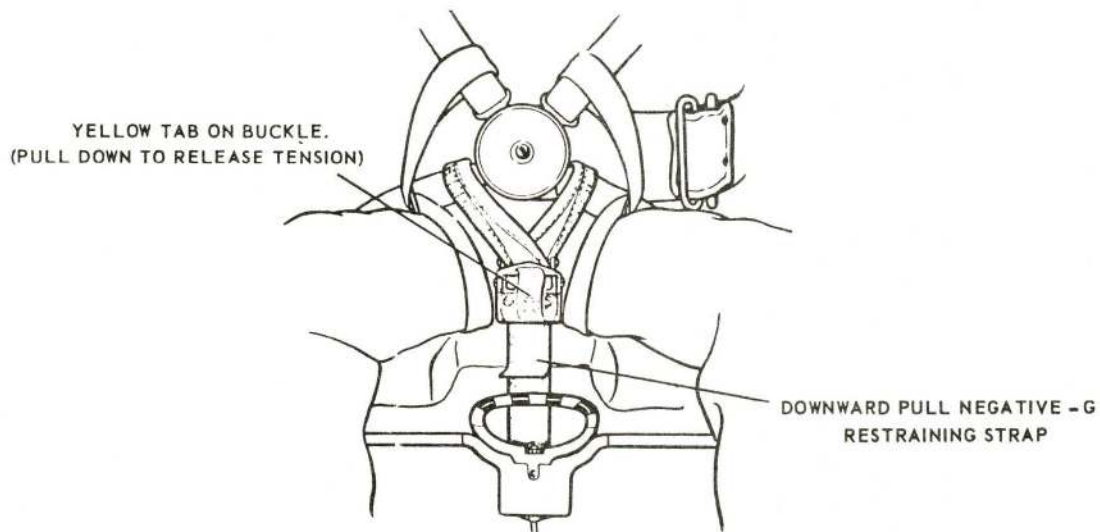

Fig. 2 Arrangement of downward pull negative-G restraining strap to lap straps

RESTRICTED

This file was downloaded
from the RTFM Library.

Link: www.scottbouch.com/rtfm

Please see site for usage terms,
and more aircraft documents.

