

Appendix 2

AIRCRAFT FITTED WITH TYPE 4BSB MK.2 EJECTION SEAT

LIST OF CONTENTS

	Para.		Para.
Composition of the assembly	1	Strapping in procedure ..	16
The Type 4BSB Mk. 2 ejection seat	2	Emergencies	18
Connections to the aircraft ..	13	Leaving the aircraft after landing	20
Equipping the seat	14		

LIST OF ILLUSTRATIONS

	Fig.		Fig.
Demand emergency oxygen system assembly ..	1	Installation of negative-G strap ..	5
Attachment of parachute restraining straps to paddle spreaders ..	2	The seat equipped (port) ..	6
Insertion of lug into top harness lock ..	3	The seat equipped (starboard)	7
Arrangement on port side of drogue container	4	Arrangement of leg restraint cords ..	8
		The seat occupied (port)	9
		The seat occupied (starboard)	10

COMPOSITION OF THE ASSEMBLY

1. Two aircrew equipment assemblies are fitted to this aircraft, each of which consists of the following items:-

Ejection seat	Type 4 BSB Mk.2
Parachute assembly	Back Type Mk.45
Personal survival pack	Type V (c/w cushion)
Emergency oxygen system	Group assembly Type 120 Mk. 1 (Ref. No. 6D/2789)
Flying clothing assembly	To be issued later

The Type 4 BSB Mk.2 ejection seat

2. The Type 4 BSB Mk.2 seat is ejected from the aircraft by a cartridge operated gun, the seat sliding up two guide rails attached to the cylinder tube of the ejection gun and the gun being attached to the airframe by brackets

3. A combined safety and parachute harness is attached to the seat at three quick-release points. It can be released in two ways, by the action of a barostatic time release unit, or by the operation of a manual separation handle, situated on the

port side of the seat pan. A 'go-forward' harness release control is situated on the port side of the seat pan, and is operated by a three position, spring loaded lever. If, the lever is pushed fully forward and then released to the centre position, the occupant can lean forward and backward at will. Return of the lever to the rear position brings the snubbing unit in the top harness lock into action, preventing further forward movement and automatically locking the harness in the rearward position as the occupant leans back. In the event of a crash landing or ejection occurring whilst the lever is in the central position, an automatic inertia device brings the snubbing unit into action to prevent the occupant being thrown forward.

4. A negative-G restraint strap is fitted to restrain the occupant against vertical movement when subjected to negative-G forces. The strap passes through brackets in the floor of the seat pan, the rear ends being attached to the bottom lock harness lugs and the forward ends attached to the harness lap strap lugs which are retained in the quick-release fitting. Means are provided for tensioning the strap during strapping-in procedure.

5. A Type V personal survival pack complete with its cushion is housed in the seat pan, where it forms a comfortable seat for the occupant. The pack is attached to the combined harness by side quick-release connectors and the lowering line is connected to the flying clothing during strapping-in.

6. A remote controlled demand emergency oxygen system assembly is mounted on a detachable tray and bolted to the starboard side of the seat pan. The emergency oxygen supply is turned on automatically during ejection and is capable of both pressure jerkin inflation and meeting the breathing requirements of the occupant. A knob situated on the starboard side of the front face of the seat pan provides manual control of the emergency system in the event of failure of the aircraft main oxygen supply. Details of the seat mounted oxygen system are contained in A.P 1275G, Vol. 1 (2nd edition), Part 2, Sect. 6, Chap. 1

7. A personal equipment connector (P.E.C.) bolted to the side plate of the seat mounted oxygen tray, enables the seat occupant to connect or disconnect in one action, the main and emergency oxygen, the air ventilated suit, the anti-G suit and the Mic/Tel services. During ejection, it automatically disconnects the air ventilated suit, the anti-G suit and the Mic/Tel services between the seat and the aircraft. The main oxygen supply between the seat and the aircraft is disconnected during ejection, at the quick-release plug mounted on the oxygen tray. When separation of the seat and occupant occurs after ejection, the P.E.C. enables the occupant to be automatically disconnected from all services on the seat. A full description of the P.E.C. is contained in Book 1, Sect. 1, Chap. 5. The connector is comprised of three components.

- (1) *Aircraft component.* Connected to the cockpit floor by a static line.
- (2) *Seat component.* Bolted to the oxygen tray
- (3) *Personal component.* Attached to the flying clothing.

8. Two firing handles are fitted to the seat. The face screen handle, attached to the face screen, projects from the front of the drogue container. The seat pan handle is positioned on the top front edge of the seat pan, and is intended for use when the occupant is unable to reach the face screen firing handle, e.g. when subjected to

high G loading. Operation of either handle jettisons the canopy and ejects the seat. A restrictor, fitted to the breech type time-delayed firing unit of the ejection gun, prevents the firing of the unit before the canopy has been jettisoned. The canopy can be jettisoned, without ejection taking place, by the operation of a handle on the cockpit console.

9. Leg restraint cords are fitted to ensure that the occupant's legs are drawn back and restrained close to the seat pan, reducing the possibility of injury during ejection. An inter-connection between the leg restraint cord sockets and the P.E.C. ensures the cords become disconnected when the personal component of the P.E.C. is disconnected. This inter-connection also ensures that the leg restraint cords cannot be connected unless the personal component is correctly engaged with, and locked to the seat component.

10. Seat height adjustment is achieved by an electrically operated actuator, controlled by a switch on the cockpit console. The switch is spring loaded to the central (OFF) position, forward movement of the switch lowers the seat and rearward movement raises it.

11. Fully automatic facilities are provided to withdraw the parachute and separate the occupant from the seat after ejection. In the event of failure of the automatic facilities, or failure to eject, a manual separation handle is fitted on the port side of the seat, which when operated will free the occupant from the seat enabling him to make a manual separation from the seat. When the occupant separates from the seat after the operation of the manual separation handle, a static line attached to the rear of the parachute pack withdraws the seat from the guillotine firing unit on the port side of the drogue container. This causes the guillotine firing unit to fire severing the parachute withdrawal line and separating the parachute from the seat structure. The parachute is then deployed by pulling the D-handle attached to the waistband of the harness.

Note

The guillotine firing unit also fires during automatic separation from the seat, but the parachute withdrawal line is pulled out from the yellow gate of the guillotine firing unit by the drogues as soon as the scissor shackle is released and before the occupant separates from the seat.

12. A full description of the Type 4BSB Mk. 2 seat will be found in A.P.4288D, Vol. 1. The parachute assembly and personal survival pack are described in A.P.1182A, Vol. 1 and A.P.1182C, Vol. 1 respectively

Connections to the aircraft

13. When a seat is installed in an aircraft the following items are connected to the airframe or fixed portion of the seat :-

- (1) *Port side of seat :-*
 - (a) Static rod from drogue gun to cross beam.
- (2) *Starboard side of seat :-*
 - (a) Static rod from barostatic time release unit to cross beam.
 - (b) Static line from aircraft component of the P E.C. to airframe.
 - (c) All P E.C. services.
 - (d) Main oxygen supply and static line from main oxygen disconnect.
 - (e) Electric supply leads to seat actuator and oxygen assembly
- (3) *Underside of seat :-*
 - (a) Leg restraint cord rollers to brackets on the cockpit floor.
- (4) *Top of seat :-*
 - (a) Static line from the canopy to the restrictor on the firing unit.
 - (b) Face screen firing cable to the canopy jettison torque shaft.

EQUIPPING THE SEAT

14. Before equipping the seat, make sure that it has been made safe for servicing in accordance with A.P.4288D, Vol. 5.

15. The following procedure is to be followed when equipping the seat, refer to figs. 1 to 7

- (1) The emergency oxygen system (*fig. 1*) must be fitted in accordance with A.P.4288D, Vol. 5, before the seat is installed in the aircraft.
- (2) Ensure that the safety pin has been

removed from the emergency oxygen release mechanism.

- (3) Ensure that the seat pan is clean and that the leg restraint cords are clear of the seat pan.
- (4) Open the paddle spreaders, situated in front of the top harness lock and pass the O rings of the two parachute restraining straps over the paddle spreaders, one over each spreader. Ensure that each O ring is pushed well back towards the pivot end of its paddle spreader, and close the paddle spreaders inwards towards each other as far as they will go (*fig. 2*).
- (5) Place the parachute pack in the parachute container, guiding the static line for the guillotine through its aperture in the back plate. Push the pack well into the container so that it is supported on the support bracket. Bring the two parachute restraining straps through the arch of the pack, ensuring that they are not crossed.
- (6) Ensure that the manual separation handle is in the locked position.
- (7) Move the 'go-forward' lever to the fully forward position and then release it to the centre position. Pull out the webbing strap from under the parachute support bracket and hold it against the spring tension.
- (8) Pass the webbing strap DOWNWARDS through the D-shackle attached to the harness shoulder straps, ensuring that the harness straps are not twisted. Insert the lug, fitted to the end of the webbing strap, between the inner extremities of the paddle spreaders into the top harness lock in the back of the seat (*fig. 3*). Push the lug in until it locks into position. It may be necessary to partially depress the harness release lever, situated below the barostatic time release unit, to facilitate the insertion of the lug. Check that it has locked correctly by pulling on the webbing strap. Move the 'go-forward' lever to the rear position and allow the strap to wind back.

- (9) Connect the two halves of the parachute withdrawal line/link line coupling. Open the yellow gate on the top of the guillotine and route the parachute withdrawal line through the aperture in the guillotine. Close the yellow gate and ensure that it correctly retains the parachute withdrawal line. Only sufficient line to permit the connection should be withdrawn from the parachute.
- (10) Draw the free ends of the parachute restraining straps forward through the arch of the parachute pack, over the pack, and towards the rear of the seat, on either side of the drogue container.
- (11) Pass the port restraining strap over the parachute withdrawal line and insert its end through the buckle of the short restraining strap on the port side of the drogue container, from the outside inwards. Ensure that the drogue link line, which is connected to the parachute withdrawal line is routed OUTSIDE the short restraining strap (*fig. 4*).
- (12) Insert the end of the starboard restraining strap through the buckle of the short restraining strap on the starboard side of the drogue container, from the outside inwards.
- (13) Position the headrest wedge pad centrally on the top of the parachute pack, between the pack and the drogue container and ensure that it is not inverted. Pass the ends of the parachute restraining straps through the buckles on each side of the headrest wedge pad so that the ends emerge on the outside of the buckles.
- (14) Work the straps back and forth in the self-locking buckles on the headrest wedge pad until the parachute pack and headrest wedge pad are strapped tightly to the seat. Pass the free ends back through the buckles on the short restraining straps and stow them neatly between the drogue container and the strap.
- (15) Check that the drogue withdrawal line has been routed OVER all other lines (*fig. 4*).
- (16) Ensure that the safety pin is fitted through the sear of the guillotine firing unit. Attach the guillotine static line to the sear.
- (17) Lift the harness clear of the seat pan and fit the negative-G restraint strap
 - (a) Thread the white straps through the front bracket on the floor of the seat pan from front to rear. The white straps are marked PORT and STARBOARD; it is essential that they are so positioned to ensure correct installation.
 - (b) Pass the straps rearwards and thread each strap through its respective rear bracket on the floor of the seat pan.
 - (c) Engage the looped end of each strap over its bottom lock harness lug and insert the lugs into their locks in the back of the seat pan. ▶◀ Check that they have locked correctly by pulling on the lugs. Ensure that the harness is arranged correctly and that none of the straps are twisted.
 - (d) Drape the blue Y-piece of the negative-G restraint strap OVER THE TOP of the seat pan firing handle.
- (18) Fit the personal survival pack into the seat pan, draping the lowering line over the port side of the seat pan.
- (19) Secure the cushion to the seat strap of the harness by passing the strap under the cushion and locating it in position with the two press-studded beackets.
- (20) Pass the leather covered straps of the cushion through the two webbing loops on either side of the personal survival pack from rear to front. Pass the leg straps of the combined harness up through the slot in the cushion and secure the cushion to the pack with the lift-the-dot fasteners. Ensure that the leg loops are not crossed.
- (21) Connect the side quick-release couplings of the personal survival pack to the couplings on the harness, ensuring

RESTRICTED

that they pass outside the harness lap straps.

- (22) Insert the harness sticker straps into the spring clips on the inside of the seat pan bringing the strap upon the inboard side of, then over and outside the personal survival pack side quick-release couplings. Ensure that none of the straps are twisted.
- (23) Fully extend all straps and place the harness straps in the stowage clips situated immediately below the wind-screen arch under the cockpit coaming.
- (24) Leave the safety pins in the safe for servicing condition and report the position of the pins to the N.C.O i/c aircraft servicing.

STRAPPING-IN PROCEDURE

16. The procedure for strapping-in is as follows:
Refer to figs. 8 to 10.

- (1) Ensure that the safety pins are correctly fitted in the 'safe for parking' condition.
- (2) Check that the static rods from the drogue gun and the barostatic time release unit are secured correctly
- (3) Grasp each lap strap and shoulder strap of the harness, pull sharply on each in turn and check for security
- (4) Sit in the seat and adjust its height; ideally the head should be central against the headrest wedge pad.
- (5) Remove the dust cover from the P E.C. and fit it into the stowage provided in the aircraft.
- (6) Connect the personal component of the P E.C to the seat portion.
- (7) Connect the personal survival pack lowering line to the corresponding fitting on the life jacket or pressure jerkin as appropriate ensuring that it passes outside the left leg.
- (8) Pass the left hand leg restraint cord through the right leg garter "D" ring and plug it into the socket above the left hand snubbing unit. Pass the right hand leg restraint cord through the left leg garter D-ring and plug it into the socket above the right hand snubbing unit. Pull sharply on both cords to ensure that they are locked correctly in their sockets. It is immaterial which cord is secured first but it is essential they are not interlaced (fig. 8).

Note . .

Unless the personal component of the P.E.C is correctly assembled to the seat portion of the P.E.C., the leg restraint cords will not lock in their sockets.

- (9) Adjust the leg restraint cords in their snubbing units to achieve the desired freedom of leg movement.
- (10) Adjust the back pad and lumbar cushion to the most comfortable position. Bring the harness waistbelt across the body and adjust the quick-release fitting so that it lies centrally, with the waistbelt close to the body. Check that the quick-release fitting is in the locked position.
- (11) Bring the negative-G restraint strap up between the legs, ensuring that it is to the REAR of the seat pan firing handle and NOT passing THROUGH it, and that the strap is not twisted. Thread the lugs of the lap straps through their respective loops in the blue Y-piece of the negative-G strap and connect the lug to the quick-release fitting on the waistbelt ensuring that the right-hand lap strap passes OUTSIDE the hoses from the personal component of the P E.C. and that the harness quick-release fitting is as low as possible consistent with comfort. To fit the harness lugs into an inertia proof quick-release fitting, turn the disc knob until the yellow line passes the dots on the body, hold it in this position and insert the first lug. Repeat the operation as each of the remaining lugs is fitted.
- (12) Tighten the lap straps.

Note . . .

The lap straps must be as tight as possible. To tighten these straps fully it is necessary to relieve the tension on the standing end of each strap (the ends that carry the buckles) otherwise the buckles become stiff. Pull on the running end with one hand and push the webbing of the standing end towards the buckle with the other; it may be necessary to do this several times before the straps are really tight; and whilst it is being done the occupant should push himself well back into the seat.

- (13) Tighten the negative-G strap by pulling DOWNWARDS on the free end of the blue strap until the strap is as tight as possible. Ensure that the free end is tucked down BEHIND the seat pan firing handle. The strap is fitted with a buckle incorporating a snubber which is released by pulling down on the yellow tab attached to the snubber lever.
- (14) Pass the left leg loop upward over the inside thigh and through the D-ring on the left lap strap, from the inside of the ring towards the outside of the leg. Bring the end of the leg loop towards the quick-release fitting, ensuring that the leg loop lies flat on the thigh. Pass the lug of the left shoulder strap through the leg loop (from the top downwards) and insert the lug into its appropriate slot in the quick-release fitting; snug the loop down over the lug. Repeat for the right leg loop and shoulder strap, ensuring that the shoulder strap passes OVER the oxygen supply hose. Ensure that the leg loops do not obstruct the quick-release fitting.
- (15) Ensure that the shoulder straps pass UNDER the folds of the life jacket or pressure jerkin stole, and tighten the inner (blue) straps, followed by the outer (khaki) straps. This will ruck the lift webs between the straps. The assistance of a ground crew member should be obtained to straighten the rucks and tuck the excess neatly behind the back. The shoulder straps

should not be over tightened as this may lead to an arched back and possible injury during ejection.

- (16) Put on the flying helmet and protective helmet or partial pressure helmet, whichever is applicable, and fasten the chin straps. Ensure that the oxygen supply is connected to the oxygen mask or partial pressure helmet. Connect the Mic/Tel lead.

Note . . .

If the chin straps are not fastened, the helmet and oxygen mask may be wrenched off during ejection with the consequent loss of vital oxygen at high altitude.

- (17) Check that the face screen handle can be reached with both hands simultaneously
- (18) With the assistance of a ground crew member remove the safety pins from the "safe for parking" condition. Place the pins in the stowage provided.

Note . . .

If a ground crew member is not available, the occupant must remove and stow all safety pins.

17. After strapping in proceed with the following functional checks:-

- (1) Check that the personal component of the P E.C is locked to the seat component by applying pressure under the handle without touching the release trigger.
- (2) Check that the leg restraint cords are locked in their sockets.
- (3) Move to the maximum extent left and right and check that this movement does not place undue strain on the hoses from the personal component of the P E.C.
- (4) Raise and lower the seat to its full extent and check that the aircraft component of the P E.C. remains locked to the seat component. Reposition the seat to the desired height.
- (5) Operate the "go-forward" lever and check for correct functioning of the "go-forward" mechanism.

EMERGENCIES

18. Instructions for dealing with emergencies are contained in A.P.4700E-P.N. (T Mk. 5).

LEAVING THE AIRCRAFT AFTER LANDING

19. The following procedure is to be followed when leaving the aircraft after landing:-

- (1) Remove the safety pins from their stowage and with the assistance of a ground crew member insert the safety pins in the "safe for parking" condition.

Note . . .

If a ground crew member is not available, the occupant must position all safety pins himself.

- (2) Operate the harness quick-release fitting, free the harness straps and return the fitting to the locked position. Stow the straps in the clips provided in the cockpit.
- (3) Disconnect the oxygen supply
- (4) Remove the personal component of the P E.C. from the seat component and free the leg restraint cords from the garters.
- (5) Fit the P E.C. dust cover.
- (6) Disconnect the personal survival pack lowering line.
- (7) Disconnect the Mic/Tel lead.
- (8) Vacate the aircraft.

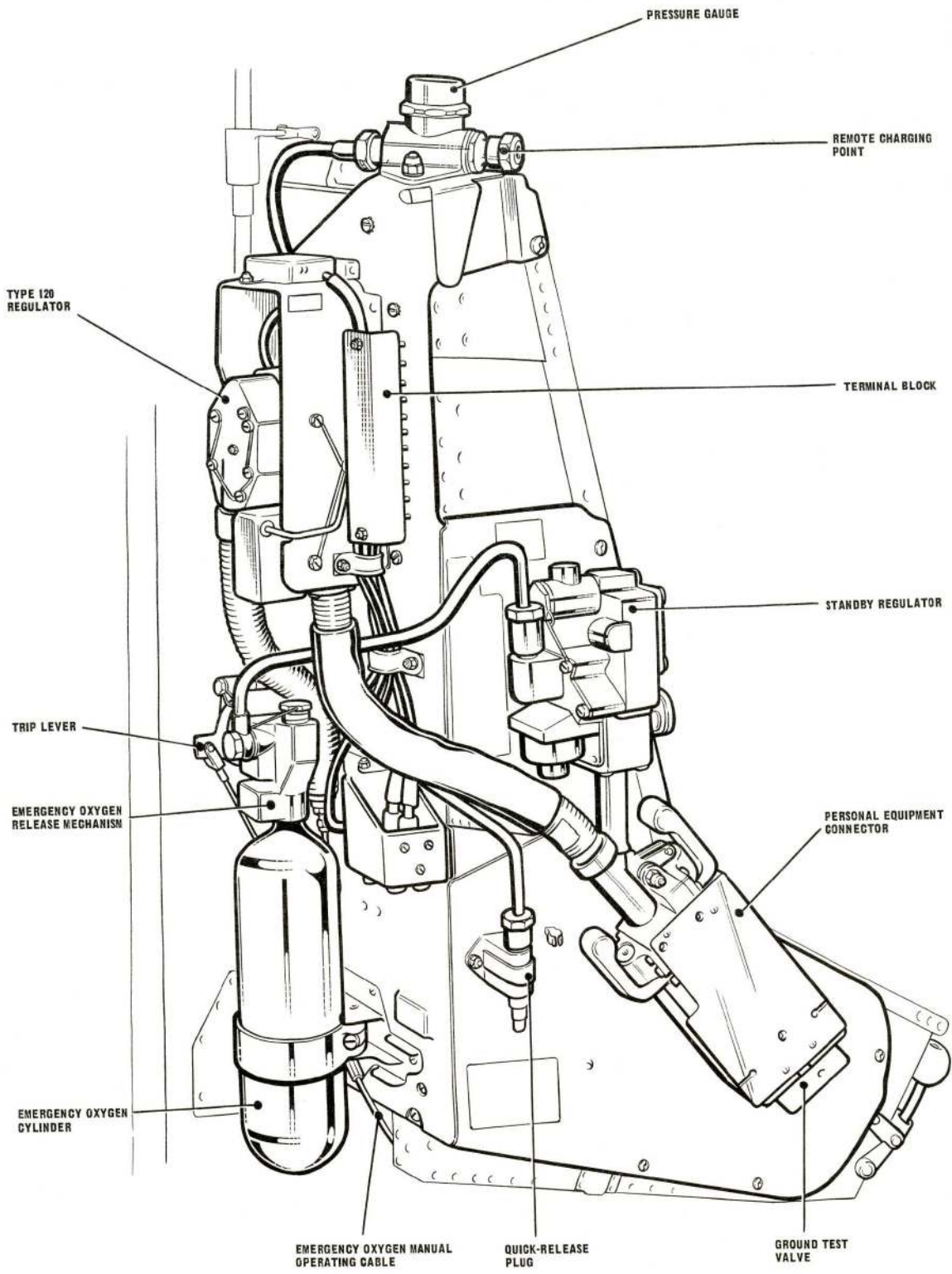

Fig. 1. Demand emergency oxygen system assembly

RESTRICTED

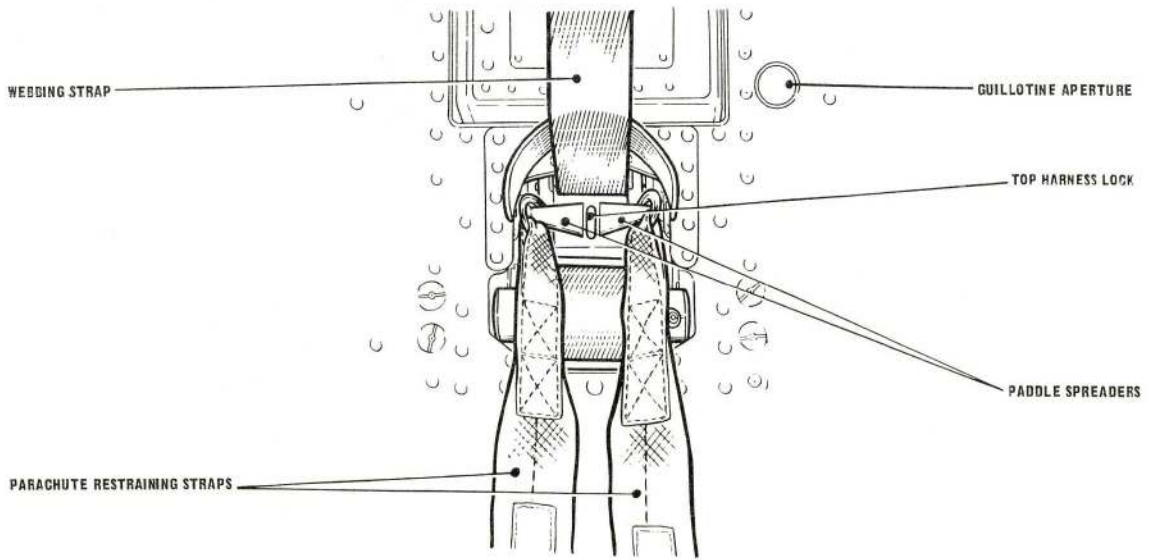

Fig. 2. Attachment of parachute restraining straps to paddle spreaders

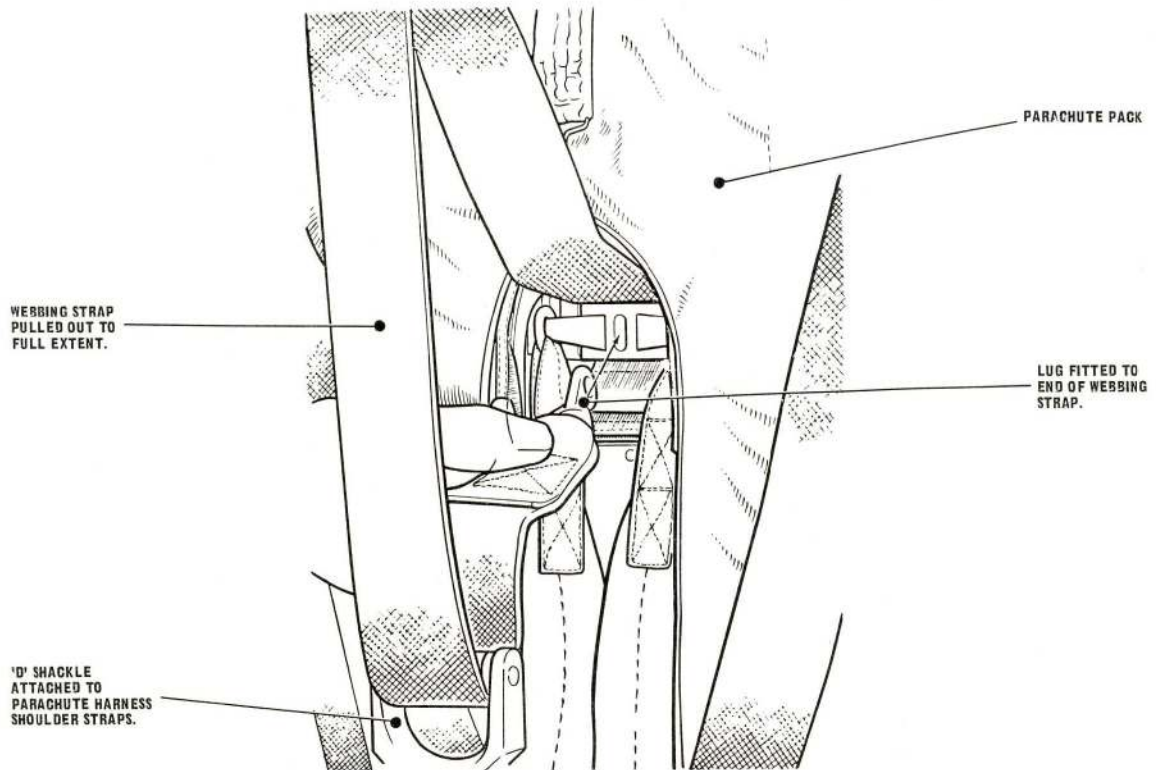

Fig. 3. Insertion of lug into top harness lock

RESTRICTED

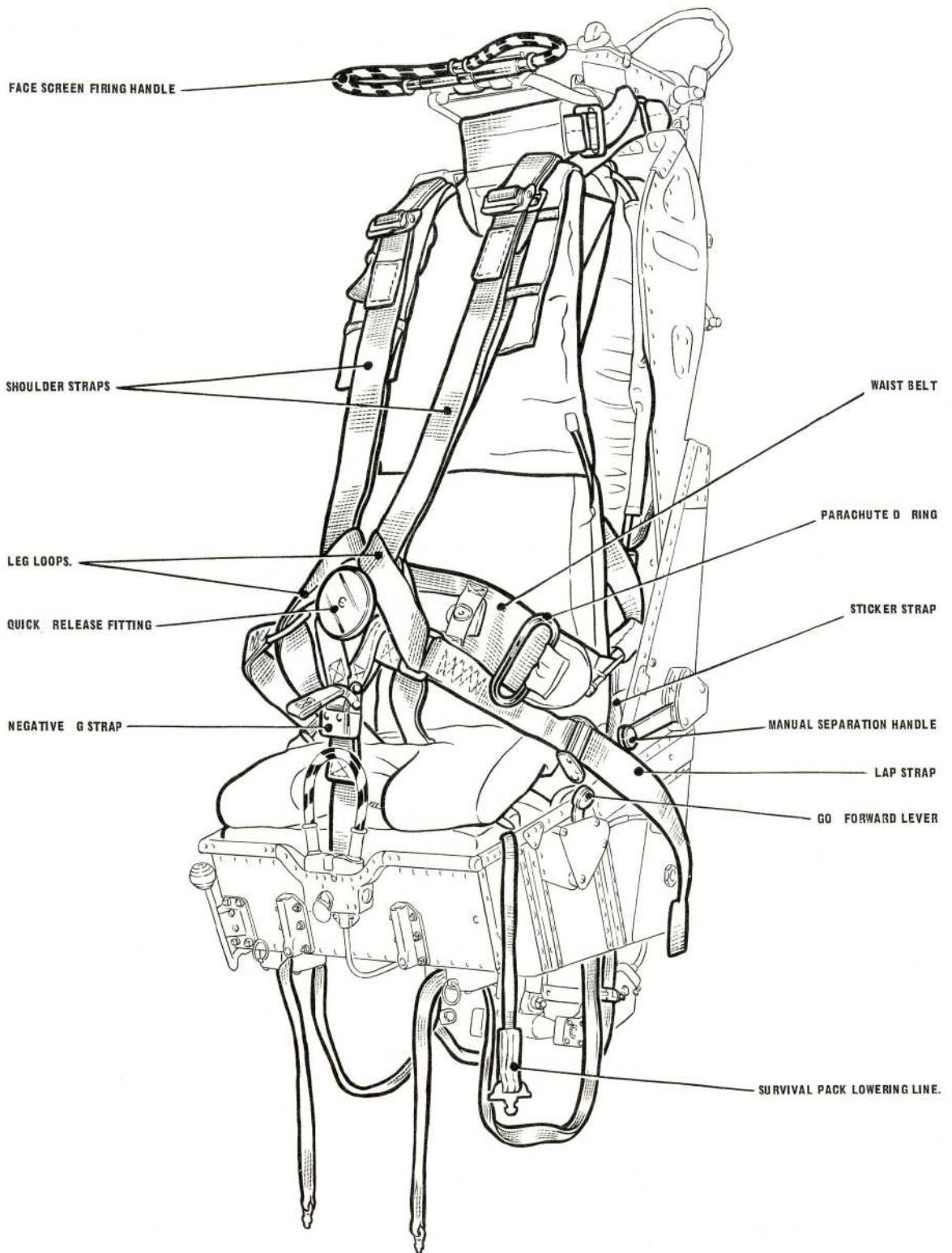

Fig. 6. The seat equipped (port)

RESTRICTED

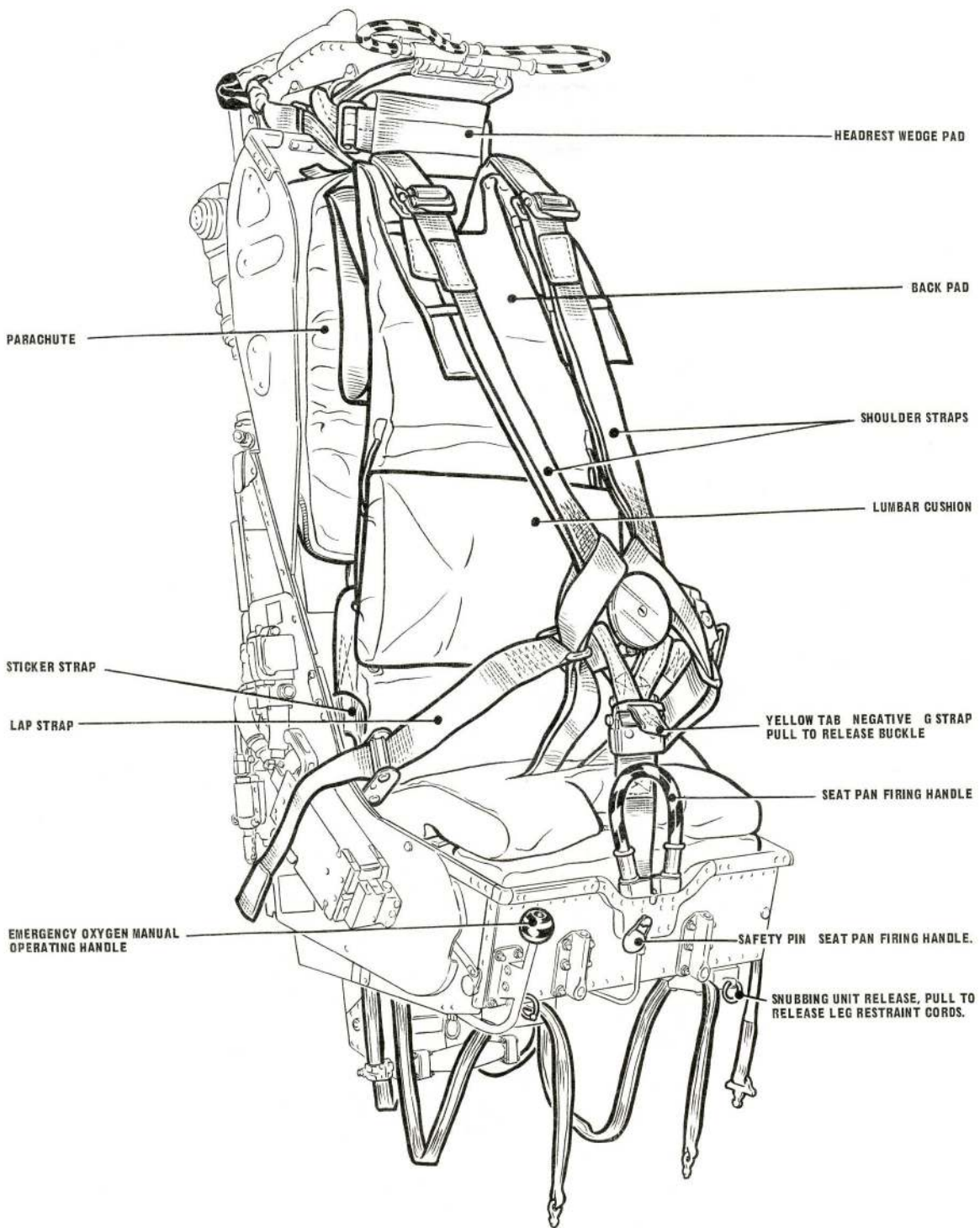

Fig. 7. The seat equipped (starboard)

RESTRICTED

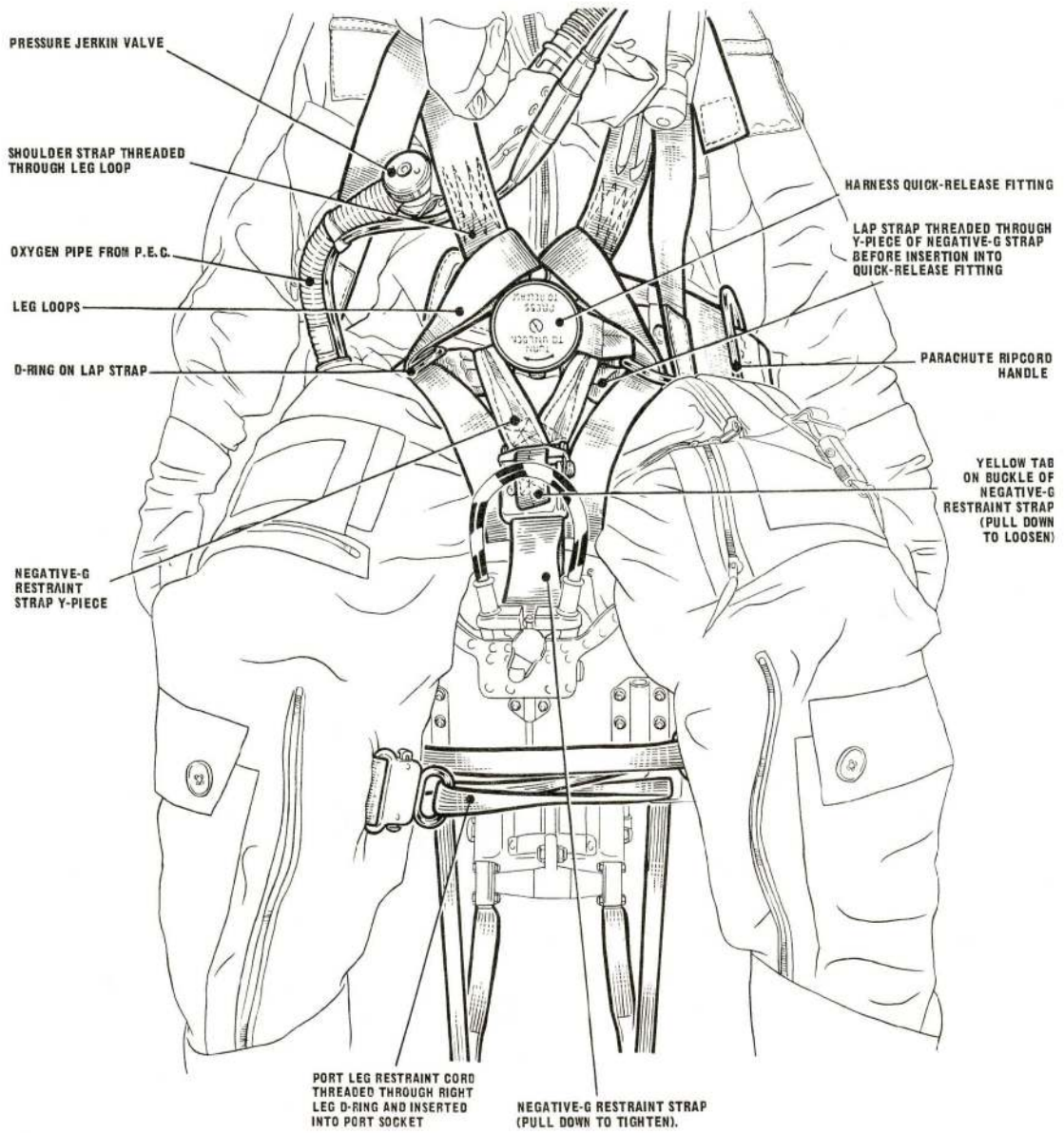

Fig. 8. Arrangement of leg restraint cords

RESTRICTED

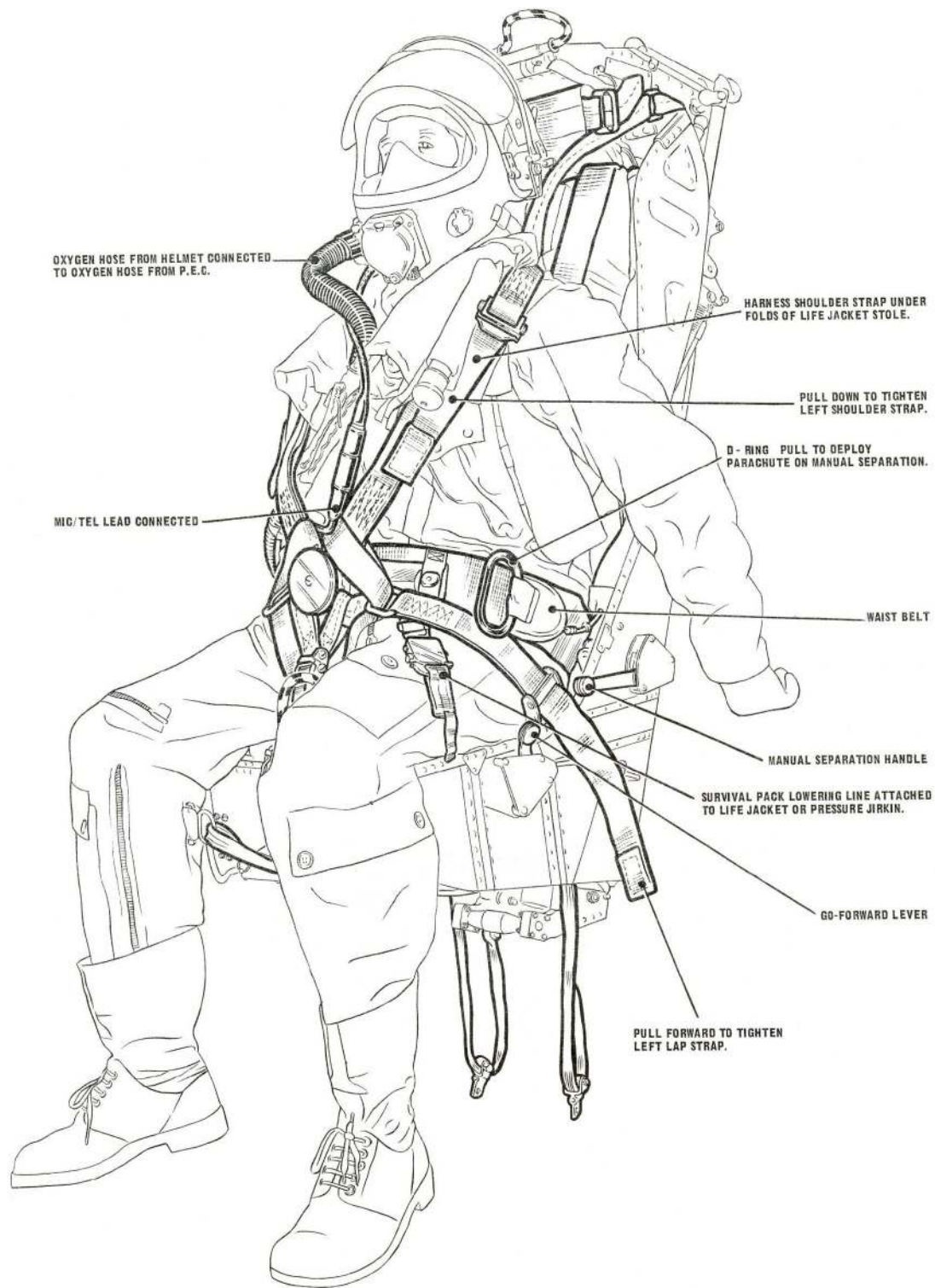

Fig. 9. The seat occupied (port)

RESTRICTED

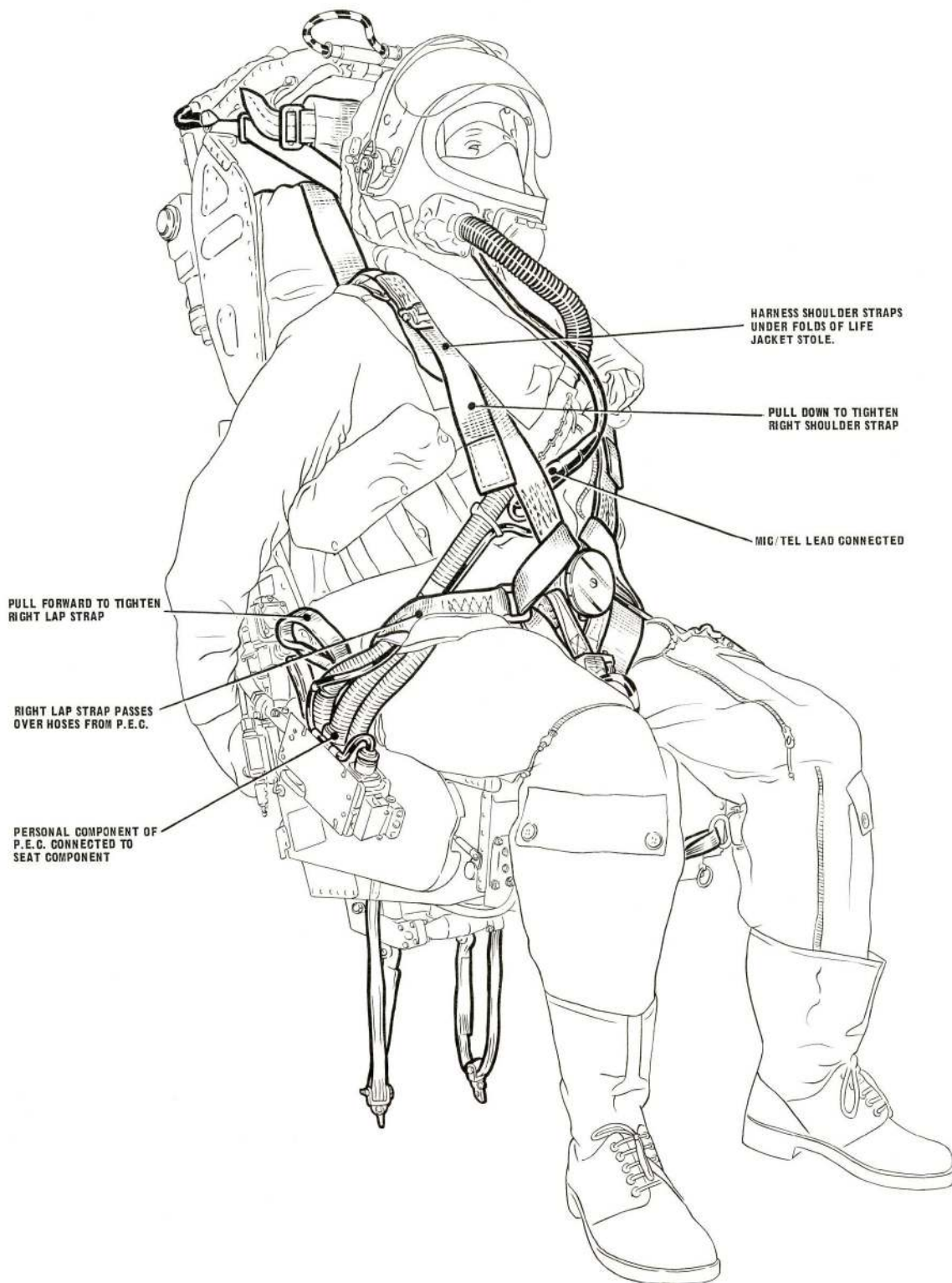

Fig. 10. The seat occupied (starboard)

RESTRICTED

This file was downloaded
from the RTFM Library.

Link: www.scottbouch.com/rtfm

Please see site for usage terms,
and more aircraft documents.



**TELEBRIEF
CONNECTIONS**

E