

AIR PURIFICATION UNIT

VOLUME 3 PART 1

Published June 1959

1st Edition

# HUNTER F MK. 4

## SCHEDULE OF SPARE PARTS

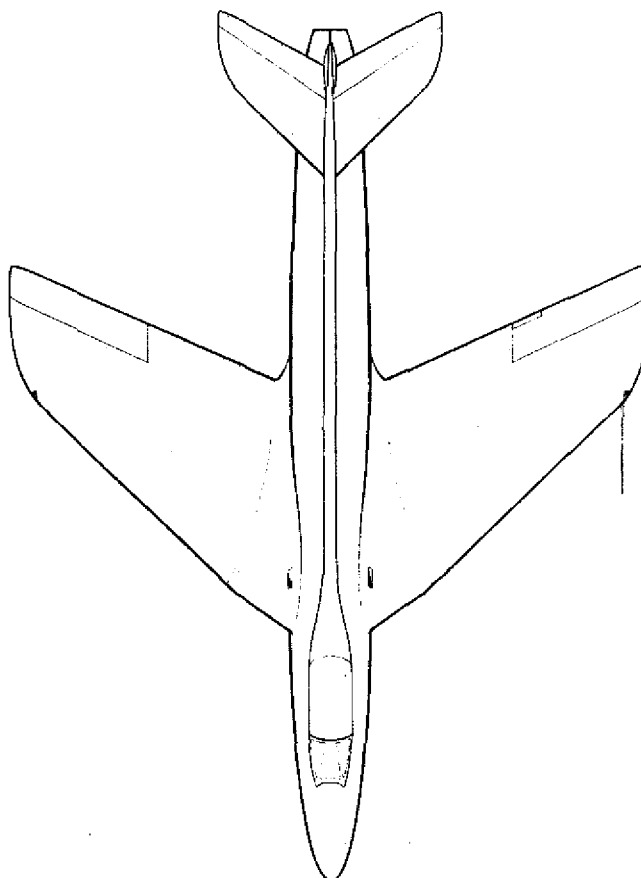
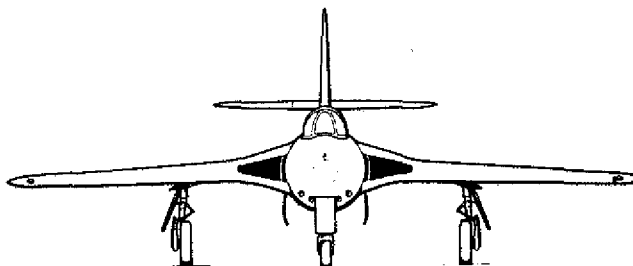
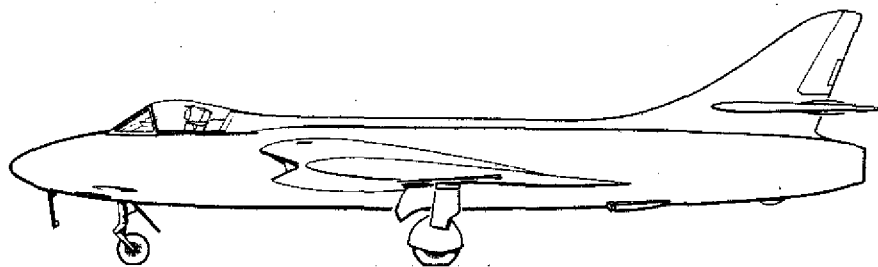

MAIN DIMENSIONS

WING SPAN	33' 8"
OVERALL LENGTH	45' 10.5"
OVERALL HEIGHT	13' 4"
INCIDENCE MAIN PLANES	+1° 30'
INCIDENCE TAIL PLANE	VARIABLE
DIHEDRAL	-1°
CHORD ROOT	13' 1"
CHORD TIP	6' 1"

AREAS

MAIN PLANES WITH AILERONS	EACH	170.0	SQ.FT
AILERONS	EACH	13.26	SQ.FT
TAIL PLANE WITH ELEVATORS		53.9	SQ.FT
ELEVATORS	EACH	8.15	SQ.FT
FIN DETACHABLE PORTION		13.0	SQ.FT
RUDDER WITH TAB		6.1	SQ.FT

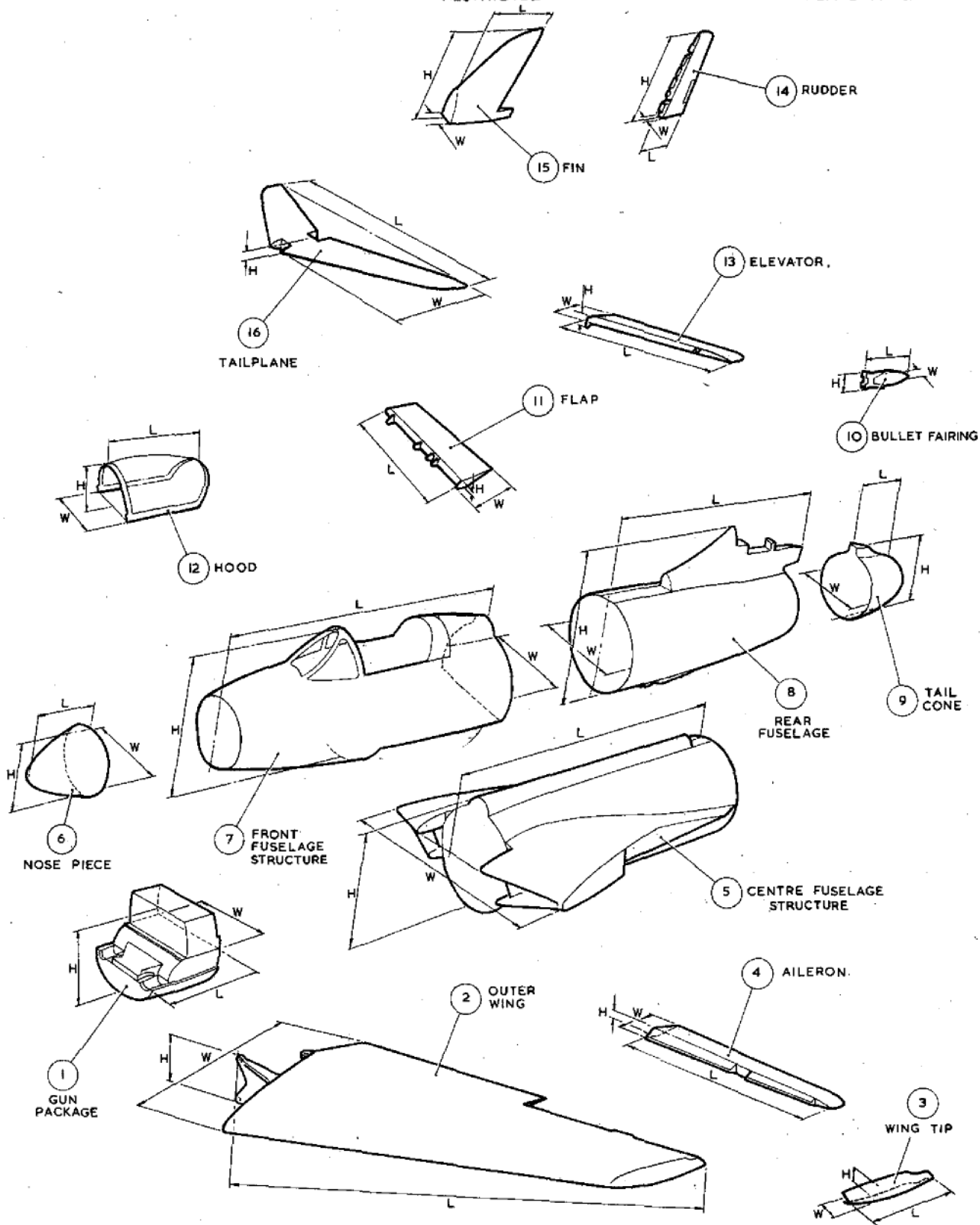

HUNTER MK. 4 & 5

PACKING DIMENSIONS

	1	2	3	4	5	6	7	8	9	10	11	12	13	14	15	16
HEIGHT H	3'-6"	2'-1"	7"	5"	5'	2'-7 1/2"	5'-6 3/4"	6'-9 1/2"	3'-6 1/2"	10 1/2"	5"	1'-10"	9"	5'-2"	6'-0"	6 1/2"
WIDTH W	3'-9"	11'-4"	10 1/2"	2'-7"	10'	2'-4 1/2"	4'-8 1/2"	4'-2 1/2"	3'-2"	9"	2'-7"	2'-4"	1'-11"	8"	7 1/2"	7'-11"
LENGTH L	3'-10"	19'-8"	5'-4"	8'-8"	16'	2'-5 1/2"	12'-7"	15'-0"	3'-4 1/2"	3'-5 1/2"	7'-6"	4'-1 1/2"	7'-8"	2'-0"	4'-10"	11'-10"
WEIGHT (LBS)	315	950	6	75	1,425	15	480	560	40	5	70	75	67 1/2	35	60	206

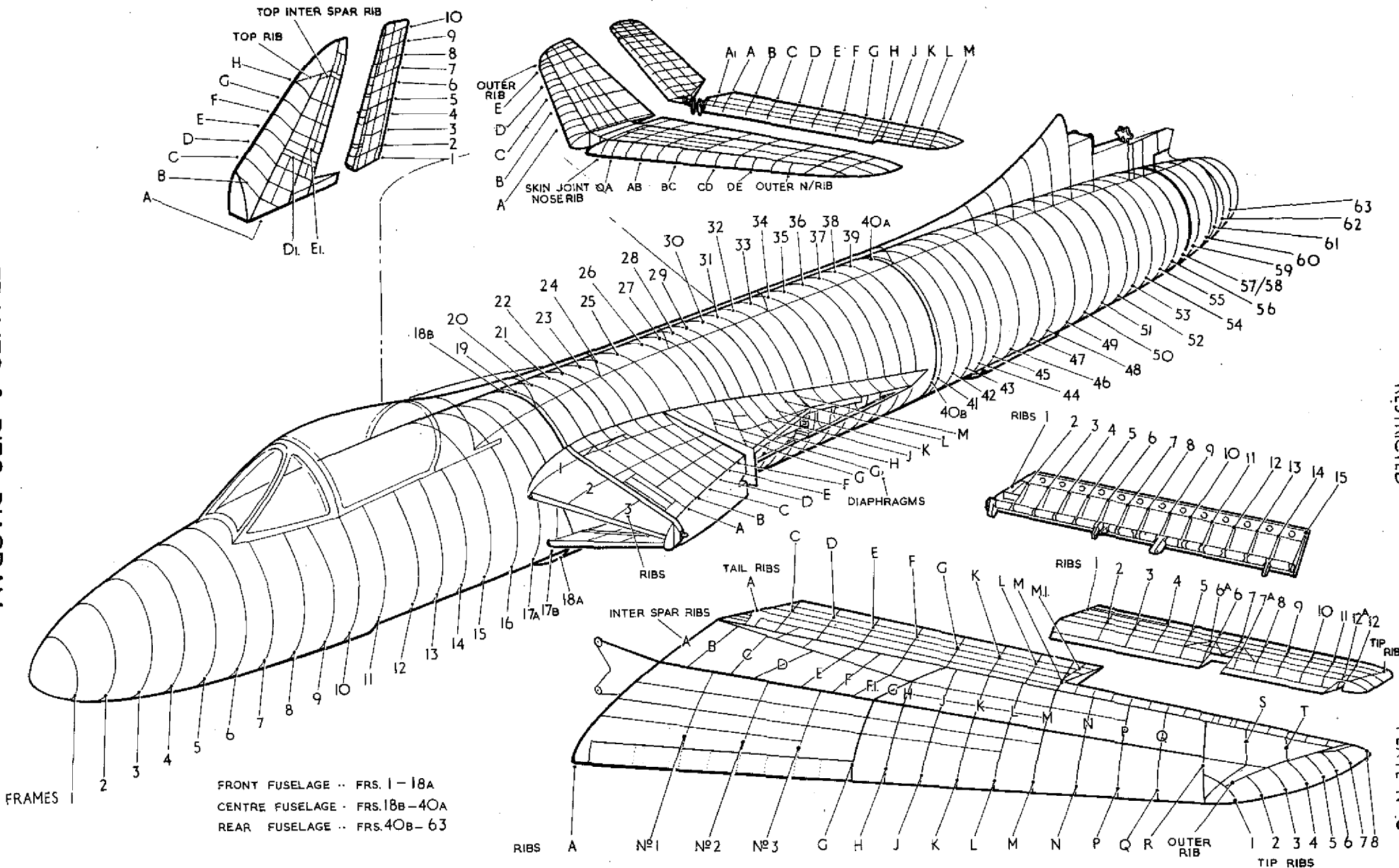

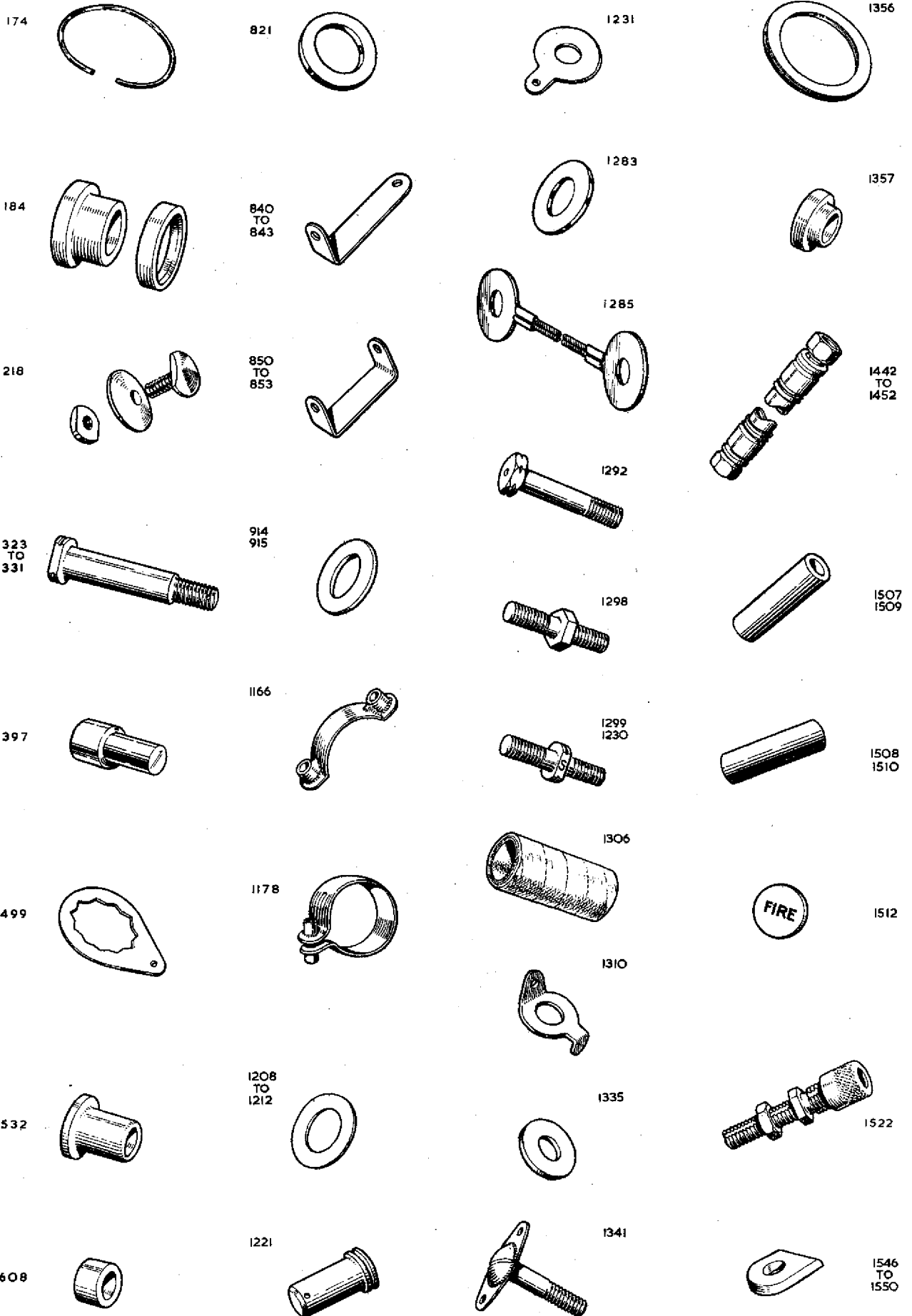

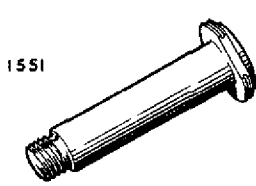

1551

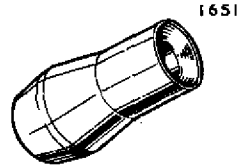

1651

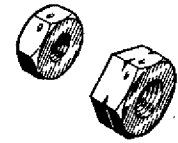

1716  
1717

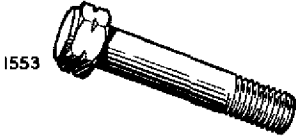

1553

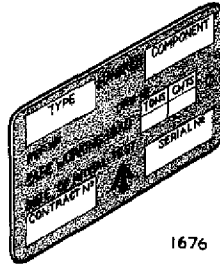

1676

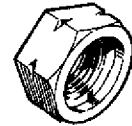

1718

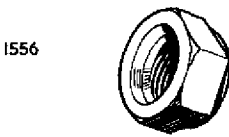

1556

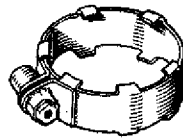

1681

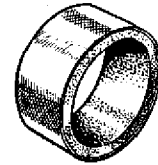

1744

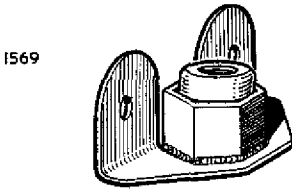

1569

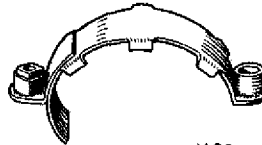

1682



1920

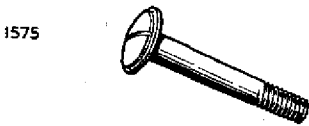

1575



1687

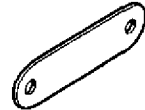

1939

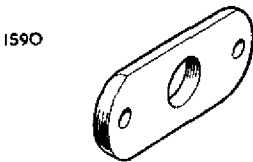

1590

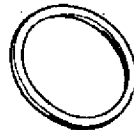

1695



1948/2  
TO  
1952/2



1606/44



1700  
1701

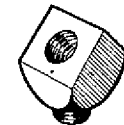

1954/45



1606/45



1702

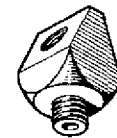

1954/45

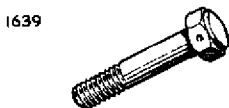

1639



1703



1959

## INDEX OF ASSEMBLIES

Assembly	Drawing No.	Page No
<b>ARMAMENT</b>		
Gun Installation ... ..	E.188207	CA.1
Gun Package ... ..	E.177081	CA.1
Gyro Gun Sight Installation ... ..	D.206360	CB.1
R.P. Installation, Removable parts ... ..	E.207133-4	CC.1
<b>CONTROLS</b>		
Engine, Centre Fuselage ... ..	D.188848	DA.1
Engine, Front Fuselage ... ..	C.188847	DB.1
Flying, Centre Fuselage ... ..	E.177242	DC.1
Flying, Fin ... ..	C.171698	DF.1
Flying, Front Fuselage... ..	E.177241	DD.1
Flying, Rear Fuselage ... ..	E.217437	DE.1
Flying, Outer Wing ... ..	D.181483-4	DG.1
Undercarriage Fairing ... ..	E.205280-1	DH.1
<b>ELECTRICAL INSTALLATION</b>		
Centre Fuselage ... ..	G.199814	EA.1
Fin ... ..	D.195638	ED.1
Front Fuselage ... ..	E.199813	EB.1
Wings (Pre Mod. 228) ... ..	D.199920-1	EE.1
Wings (Mod. 228) ... ..	D.207227-8	EF.1
Rear Fuselage ... ..	E.201043	EC.1
Auto-stabiliser Equipment (Mod. 417) ... ..	E.222499	EG.1
<b>EQUIPMENT AIRCRAFT</b>		
G.M. Compass Installation (Pre Mod. 256) ... ..	E.200068	FC.1
G.M. Compass Installation (Mod. 256) ... ..	G.212370	FC.1
Instrument Panels (Pre Mod. 691) ... ..	C.187696	FA.1
Instrument Panels (Mod. 691) (Pre Mod. 715) ... ..	C.226206	FA.1
Instrument Panels (Mod. 715) ... ..	C.229153	FA.1
Map Case (Pre Mod. 149) ... ..	A.190817	FB.1
Map Case (Mod. 149) ... ..	B.203375	FB.1
<b>EQUIPMENT ANCILLARY</b>		
Ancillary Equipment ... ..	E.189199	GA.1
<b>EQUIPMENT S.O.O.</b>		
Ballasting—Radar Head and Ranging Unit ... ..	A.199123	HA.1
Pylons—Inboard (Mod. 9) ... ..	E.206873-4	HB.1
Pylons—Inboard (Mod. 228) (Pre Mod. 463) ... ..	E.221167-8	HB.2
Pylons—Inboard (Mod. 463) ... ..	E.221165-6	HB.3
Pylons—Outboard ... ..	D.206949-50	HC.1
Drop Tank—Removable Parts ... ..	D.216989	HD.1
<b>FUSELAGE</b>		
Air Brake Assembly ... ..	D.204125	JD.11
Accumulator Mounting (Mod. 386) ... ..	B.215554	JA.1
Centre Portion Structure ... ..	E.200959	JB.1
Front Portion Structure ... ..	E.205989	JC.1
Hood Jettison Gear ... ..	E.215670	JE.1
Hood Winding Gear ... ..	D.187117	JF.1
Hood and Windscreen ... ..	D.189583	JG.1
Joints Assembly ... ..	C.177080	JA.1
Nose Piece ... ..	C.177079	JA.1
Pitôt Installation, Centre Fuselage ... ..	B.196209	JH.1
Pitôt Installation, Front Fuselage ... ..	C.187563	JJ.1
Rear Portion Complete ... ..	C.201502	JD.1
Rear Portion Structure ... ..	E.201644	JD.1
Seat Installation ... ..	D.190915	JK.1
Tail Cone (Pre Mod. 275) ... ..	C.192597	JA.2
Tail Cone (Mod. 275) (Pre Mod. 550) ... ..	C.207578	JA.2
Tail Cone (Mod. 550) ... ..	C.216040	JA.2
Wing Joint Pins ... ..	C.198779	JA.3

## INDEX OF ASSEMBLIES

Assembly	Drawing No.	Page No.
<b>MAIN PLANES</b>		
Aileron (Mod. 518) ... ..	G.217250-1	KB.1
Flap Landing ... ..	E.180473-4	KC.1
Pitôt Installation ... ..	C.199912	KD.7 KE.7
Wing, Outer, Complete (Pre Mod. 228) ... ..	D.198203-4	KA.1
Wing, Outer, Complete (Mod. 228) (Mod. 533) ... ..	D.216930-1	KA.1
Wing, Outer, Structure (Pre Mod. 228) (Mod. 533) ... ..	F.220366-7	KD.1
Wing, Outer, Structure (Mod. 228) (Mod. 533) ... ..	D.216800-1	KE.1
Wing, Outer, Spare (Mod. 228 altered to Pre Mod. 228 standard) ... ..	D.221580-1	KF.1
Wing Tip (Mod. 533) ... ..	D.216584-5	KD.17 KE.19
<b>POWER INSTALLATION</b>		
Generator Cooling ... ..	D.191791	LA.1
Gearbox and Accessories ... ..	D.187592	LB.1
Engine Installation ... ..	G.191793	LC.1
Engine Mounting ... ..	D.186357	LD.1
Fire Extinguisher Equipment ... ..	E.190871	LE.1
<b>RADIO INSTALLATION</b>		
D.M.E. (Pre Mod. 535) ... ..	D.191138	MB.1
D.M.E. (Mod. 535) ... ..	D.222747	MB.2
Equipment Mounting ... ..	D.188913	ME.1
I.F.F. ... ..	D.191416	MC.1
Radar Ranging ... ..	D.225310	MA.1
V.H.F. ... ..	G.200463	MD.1
<b>SERVICES</b>		
Fuel Filter De-icing System ... ..	{ B.219909 C.220703 E.200270	NA.1 NA.1 NB.1
Fuel System, Centre Fuselage ... ..	D.207216-7	NC.1
Fuel System, Wings (Pre Mod. 228) ... ..	E.206680-1	NC.5
Fuel System, Wings (Mod. 228) ... ..	D.191795	ND.1
Gun Heating ... ..	E.205276	NE.1
Hydraulics, Centre Fuselage ... ..	E.222095	NF.1
Hydraulics, Front Fuselage ... ..	D.187925	NG.1
Hydraulics, Rear Fuselage ... ..	E.200037-8	NH.1
Hydraulics, In Wings ... ..	D.186746	NJ.1
Oxygen Installation ... ..	D.190124	NK.1
Pilots Anti "G" Installation ... ..	C.184830	NL.1
Pressurisation, Centre Fuselage ... ..	C.184829	NM.1
Pressurisation, Front Fuselage ... ..		
<b>TAIL UNIT</b>		
Elevator ... ..	E.184985-6	PA.1
Fin (Pre Mod. 91) ... ..	D.183036	PB.1
Fin (Mod. 91) ... ..	D.207585	PB.1
Rudder (Pre Mod. 91) ... ..	D.183796	PC.1
Rudder (Mod. 91) ... ..	D.207582	PC.1
Rudder (Mod. 692) ... ..	D.226217	PC.3
Tail Plane ... ..	E.207600	PD.1
Tail Unit Assembly (Complementary Parts) ... ..	D.186469	PE.1
<b>TANKS</b>		
Fuel, Forward ... ..	{ FTH.7715-6 AM.2220-1 (Pre Mod. 547) AM.2238-9 (Mod. 547)	QA.1 QA.1 QA.1
Fuel, Rear ... ..	{ FTH.7719-20 AM.1910-11	QA.1 QA.2
Wing No. 1 ... ..	{ FTH.7725-6 AM.2101-2	QA.1 QA.2
Wing No. 2 ... ..	{ FTH.7727-8 AM.2103-4	QA.1 QA.2

INDEX OF ASSEMBLIES

Assembly	Drawing No.	Page No.
<b>TANKS (continued)</b>		
Wing No. 3 ... ..	FTH.7729-30	QA.1
	AM.2105-6	QA.2
Wing No. 4 ... ..	FTH.7731-2	QA.1
	AM.2107-8	QA.2
<b>UNDERCARRIAGE</b>		
Fairing ... ..	D.187500-1	RB.1
Main ... ..	D.187474-5	RA.1
Nose ... ..	D.186306	RC.1
Wheel Doors ... ..	D.188115	RD.1
Wheel Door Operating Gear ... ..	B.179108	RE.1

This file was downloaded  
from the RTFM Library.

Link: [www.scottbouch.com/rtfm](http://www.scottbouch.com/rtfm)

Please see site for usage terms,  
and more aircraft documents.

