

CHAPTER 1

GROUND HANDLING

LIST OF CONTENTS

	<u>Para.</u>		<u>Para.</u>
Introduction	1	Flying controls locking gear	8
Access to cabin	2	Control surface locking clamps	9
Forward towing	3	Undercarriage safety stops	10
Backward towing	4	Parking with brakes on..	11
Picketing	5	Care of engine..	12
Air intake safety guards	6	Moving a crashed aircraft	13
Weather covers..	7		

LIST OF ILLUSTRATIONS

	<u>Fig.</u>		<u>Fig.</u>
Pilot's ladder	1	Control surface locking clamps..	5
General ground equipment	2	Undercarriage safety stops	6
Picketing equipment and covers	3	Moving a crashed aircraft... ..	7
Flying controls locking gear	4		

WARNING

An aircrew ejection seat is fitted to this aircraft. Before attempting to enter the cabin, therefore, ensure that the instructions given in the Ejection Seat Warning, following the Introduction at the beginning of this volume, have been carried out. In the interests of safety, this is very important.

ENGINE

When the aircraft is being manoeuvred on the ground with the engine running, or when the engine is being run for any purpose, it is essential that personnel are given strict instructions to keep well

clear of the air intakes and jet exhaust, as to remain in proximity is hazardous to their safety. The air intake safety guards should be fitted at all times when the engine is ground run.

Introduction

1. This chapter contains the recommended procedure for handling this aircraft on the ground, together with the necessary special equipment provided for the various operations. This equipment has been designed to eliminate any possibility of damage and distortion occurring during handling and should therefore, be used in preference to other type of similar equipment, as otherwise the efficiency of the aircraft may be seriously impaired. When the aircraft is being worked upon, or ground handled in any way, ensure that the air-intake and jet exhaust blanking boards are in position as well as any other covers provided which will not impede the progress of the work in hand. This is particularly important when the weather is gusty and liable to increase the possibility of sand or dust entering the systems. The jacking, trestling and slinging of the aircraft will be found in Sect.2, Chap.4 of this publication.

Access to cabin

2. As footsteps, apart from the emergency step located between frames 10 and 11 on the port side of the fuselage, are not provided on this aircraft, a special ladder Pt. No. D.202713 must be employed to gain access to the cabin. This ladder, which is illustrated in fig.1, consists of a tubular structure with triangular supporting members assembled to the rear face and a pivoted footstep support at the top. The supporting members carry a bearing member and a support arm with a spigot, which together with the footstep engage with the aircraft. To protect the aircraft's finish, the footstep and support arm incorporate rubber rollers and the bearing member, which is shaped to conform with the fuselage contour, is also covered with rubber. One of the ladder's upright members is extended above the footstep so that it may be used as a handgrip and also seen from the seat, thus preventing the pilot from taking-off with the ladder fitted. To fit the ladder to the

aircraft, raise the pivoted footstep and retain it in the up position by the ball catch. Offer up the ladder to the aircraft and engage the spigot in the socket inside the emergency footstep. With the bearing member against the fuselage skin, push down the pivoted footstep until the ladder is locked in position.

Forward towing (fig.2)

3. The aircraft may be towed forward by a tractor with the aid of the standard towing equipment, consisting of a short towing arm Mk.1 (Stores Ref. 4G/4175) and an adjustable fork unit Mk.2 (Stores Ref.4G/4176), attached to spools on the nose wheel unit. The towing arm release mechanism must be set to release at a load of 3,000 lb. and the method of using it is described in A.P.2817A, Vol.1. When a tractor is not available, towing may be effected by the use of a rope attached to the towing arm, provided sufficient manual labour is available.

4. A special towing bridle (Stores Ref.4G/4137) is provided for backward towing, the bridle being attached to lugs on each main undercarriage leg. When using the bridle, it is recommended that the nose wheel be turned through 180 deg. so that it is trailing in the reverse direction to normal and the aircraft steered by attaching the standard steering arm (Stores Ref.4G/3070) and adjustable fork unit (Stores Ref.4G/4176) to the spools on the nose wheel unit. It is also essential to ensure that the bridle does not foul and damage the aircraft due to an excessive swing when steering.

NOTE...

At all times when the aircraft is being towed either forwards or backwards, it is recommended that a member of the ground personnel be stationed in the cabin to control the wheel brakes. After a number of brake applications it is necessary to

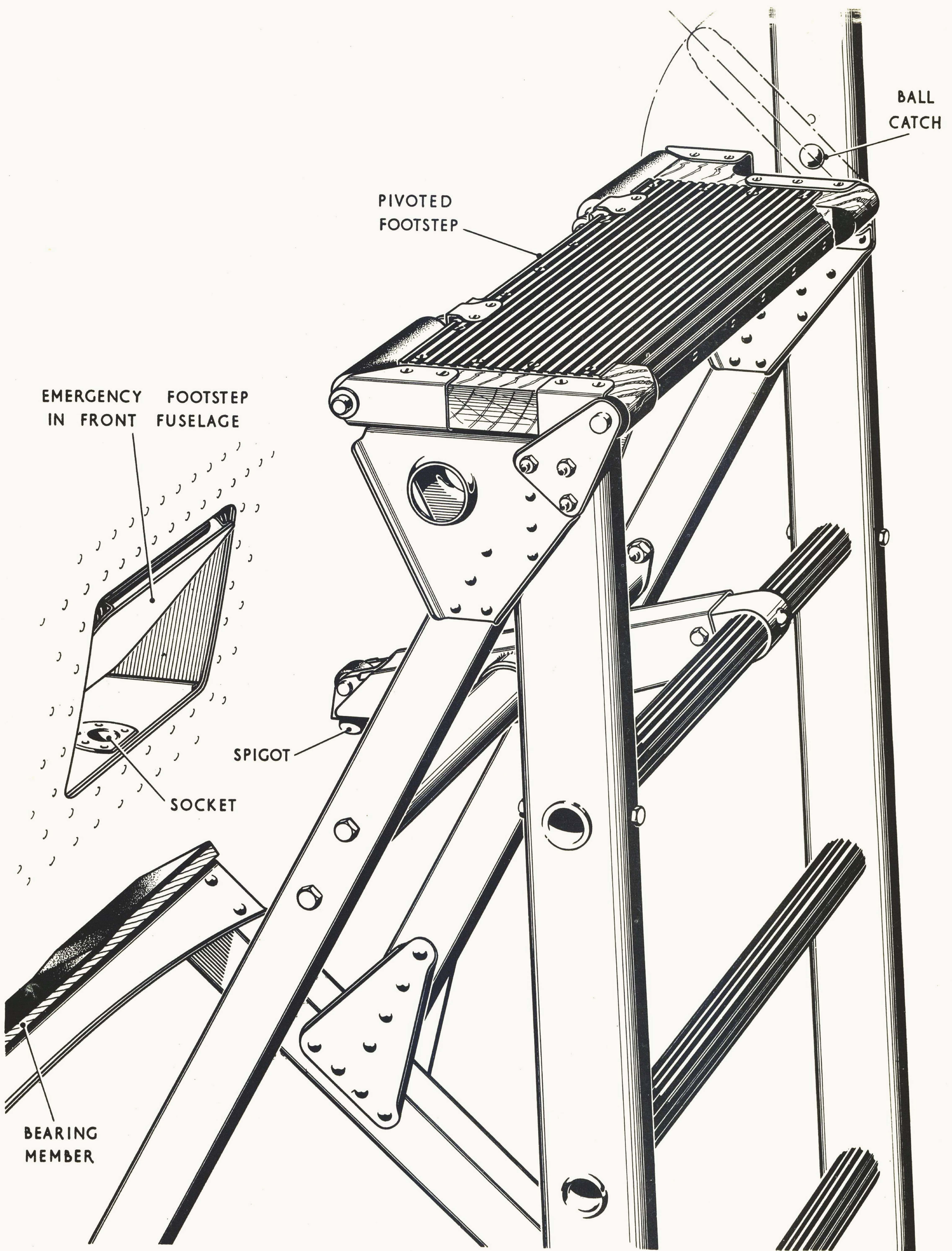

FIG.1-PILOTS LADDER

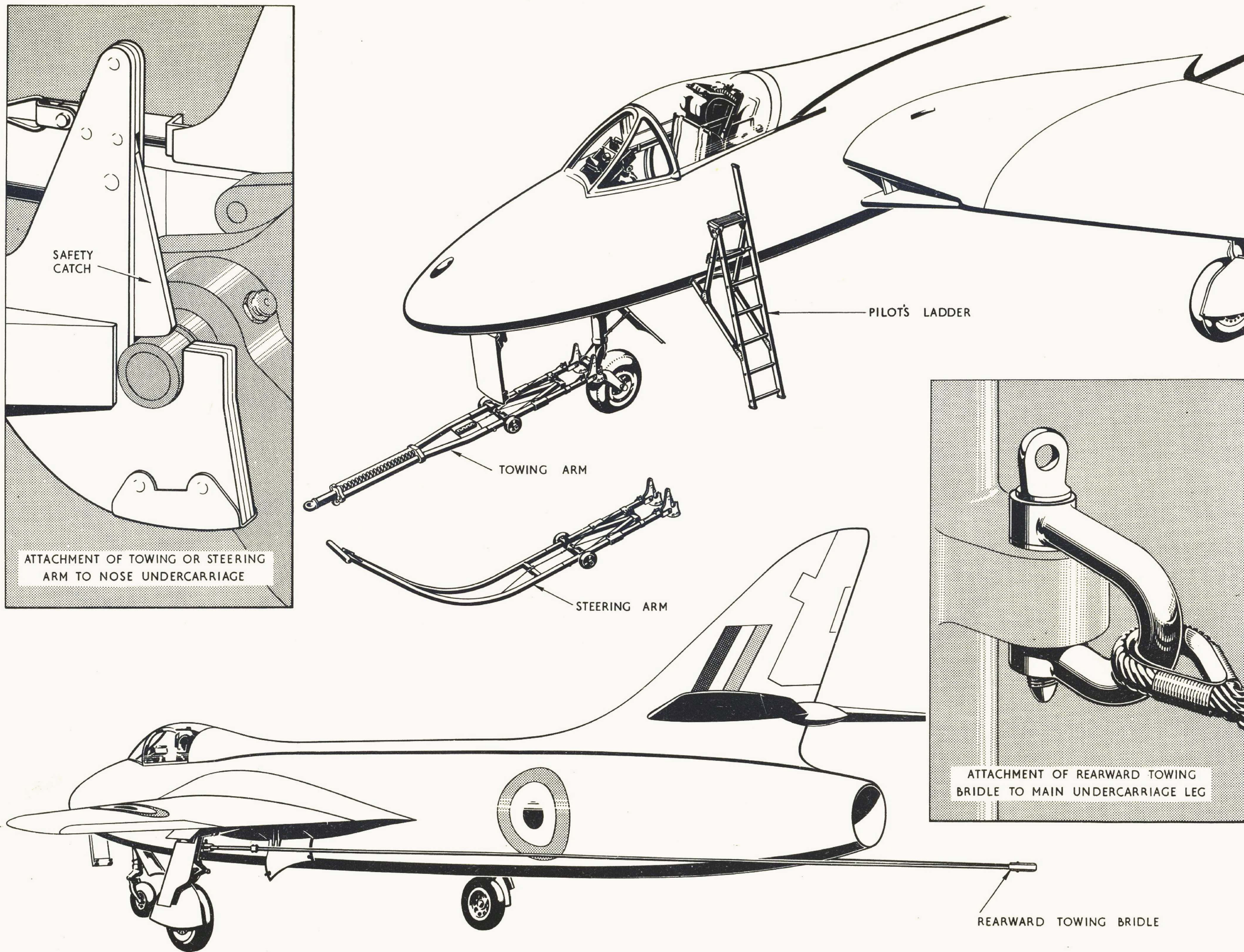

FIG. 2 GENERAL GROUND EQUIPMENT

replenish the hydraulic accumulators by use of the handpump.

Picketing (fig.3)

5. Special picketing shackles are provided for attachment to the nose wheel unit, each main undercarriage leg and to the bottom of the rear fuselage adjacent to frame 52. When picketing, a shackle Pt. No. A.176434 should be secured to the nose wheel unit by a quick-release pin passed through the attachment lugs just above the nose wheel fork. Further shackles Pt. No.A.176437, should be fitted to the lugs on each main undercarriage leg and secured in position with the collars and quick-release pins provided. The tail should be lashed down by screwing a special shackle Pt. No.F.159908, into the socket adjacent to frame 52. From these shackles the aircraft is lashed down by lengths of 2 in. Manilla rope (Stores Ref.32A/52) to suitable pickets, as indicated in the picketing illustration. Ensure that the ropes do not foul any part of the structure and that they are only just taut as otherwise subsequent rope shrinkage may cause damage. The type of picket used will be determined by the condition of the parking ground (A.P.1464G, Vol.1, Part 2, Sect.5, Chap.2). As a safeguard against the aircraft being flown with the picketing shackles in position, a red warning pennant is attached to each. These pennants must not be removed from the shackles.

Air intake safety guards (fig.3)

6. Tubular safety guards are provided for fitment to the air intakes, to safeguard personnel working on the aircraft during engine run. It is very important to ensure that these are fitted at all such times, to eliminate the possibility of a serious accident.

Weather covers (fig.3)

7. To prevent the ingress of foreign matter and moisture, blanking boards are provided for the air intakes and jet pipe outlet. These must be fitted at all times when the aircraft is parked, and also during servicing operations. Covers are provided for the cabin, centre fuselage, pressure head and for sealing the gun package compartment when the gun package is removed from the aircraft. Bungs are also provided for the gun blast tubes, link and case chutes and the boundary layer ducts.

Flying control locking gear (fig.4)

8. This gear secures the flying controls in the cabin to prevent undue movement of the control surfaces. It is only designed to secure the controls when the aircraft is parked in calm weather and must not be used alone if the weather is gusty (para.9). The procedure for fitting the gear is as follows:-

- (1) Move the seat to its lowest position and place the rudder bar pedal adjuster in the central position.
- (2) Assemble the aileron locking clip (detail C) on to the control column, push down until the tongues are firmly positioned between the aileron stops and the column and then tighten the wing nut.
- (3) Assemble the other clip (detail B) of the locking gear on to the control column above the clip fitted in sub-para. (2), as illustrated.

NOTE...

To engage this clip with the control column it is first necessary to thread the left hand forward cable and clip between the column and

brake cable, if necessary easing the brake cable out of the way.

- (4) Hook the forward pair of cables through the holes in the outer side plates of the rudder pedals.
- (5) Hook the rear pair of cables to the harness lugs (detail A).
- (6) Partially tension the cables by adjusting the seat back rest pan and obtain the correct tension by means of the adjuster nut (detail B). Once the correct adjustment has been made, subsequent installation of the locking gear may be effected by adjustment of the seat back rest pan.

Control surface locking clamps (fig.5)

9. Special control surface locking clamps are provided for use at all times when the aircraft is parked in the open in gusty weather. These are additional to the flying control locking gear, which should always be fitted first as described in para.8.

NOTE...

On no account is the flying controls locking gear to be removed while the control surface locking clamps are in position.

To fit the locking clamps, proceed as follows:-

- (1) Fit the flying control locking gear.
- (2) Insert the vertical plate (2) of the aileron locking clamp into the gap between the inner end of the aileron and wing. Pull the strap over the leading edge of the wing, tension the shock-

absorber cord (1) and secure the cord by inserting the release hook (3) in the hole in the under portion of the locking clamp.

- (3) Insert the rudder locking clamp (4) into the gap between the lower end of the rudder and the fin. Secure in position by screwing in the wing bolt (6) through the hole in fin.
- (4) Fit the elevator locking clamps (8) by passing the contour boards over the tail plane and elevators until they restrain the elevator movement and secure them in position by engaging the shock-absorber cords (7) with the attachment rings (5) on the rudder locking clamp.

NOTE...

To safeguard against the aircraft being flown with the locks fitted, red warning pennants are attached to each item. These pennants must not be removed.

Undercarriage safety stops (fig.6)

10. Special safety stops are provided to eliminate the possibility of inadvertent retraction of the undercarriage while the aircraft is on the ground. The undercarriage locks must be fitted during the following operations:-

- (1) Forward or backward towing.
- (2) Manhandling.
- (3) Servicing involving work in the wheel bay when the aircraft is jacked up.

The stop for the nose wheel leg consists of a clamping bar and a screwed rod fitted with a fork at

RESTRICTED

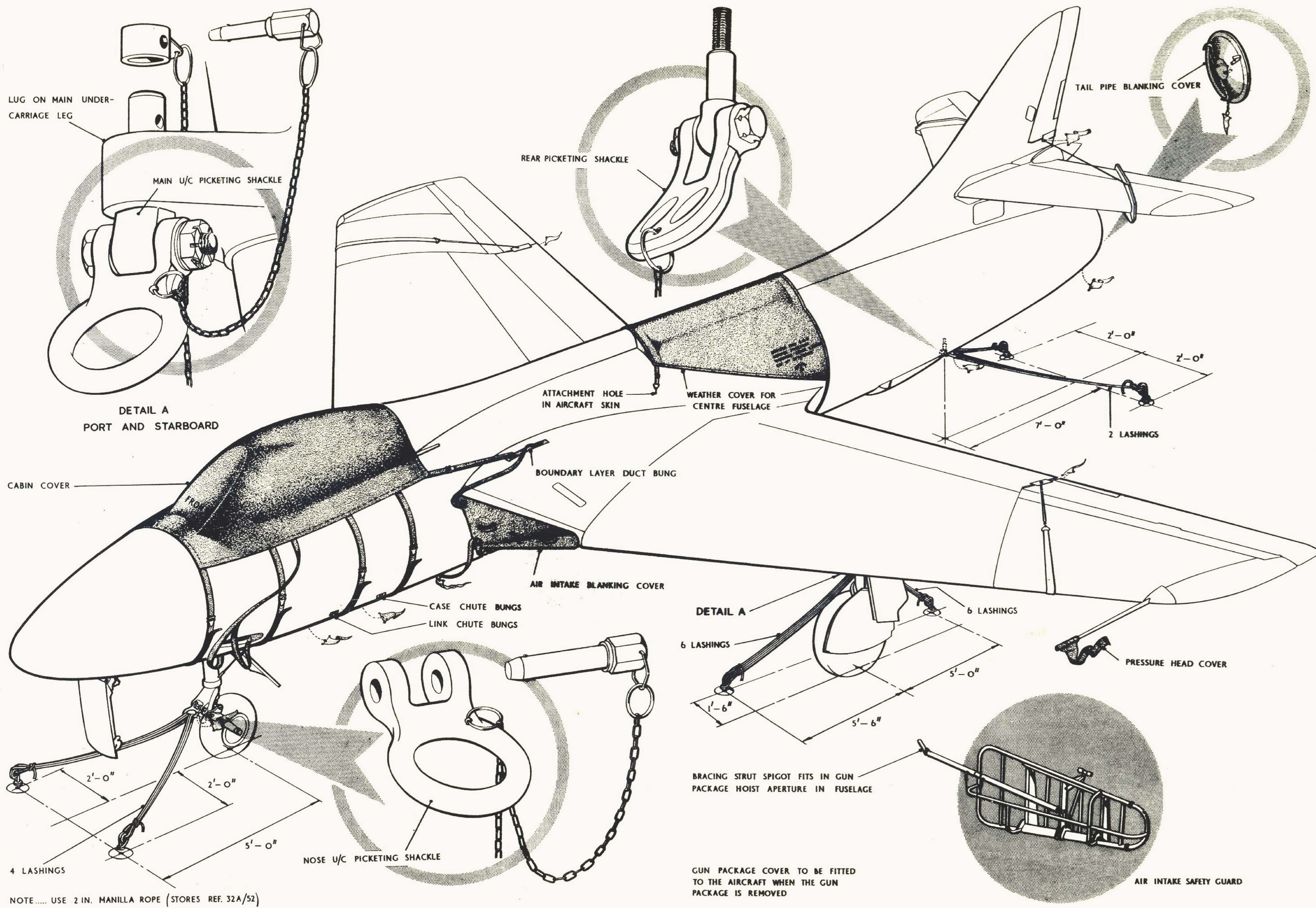

FIG. 3 PICKETING EQUIPMENT AND COVERS

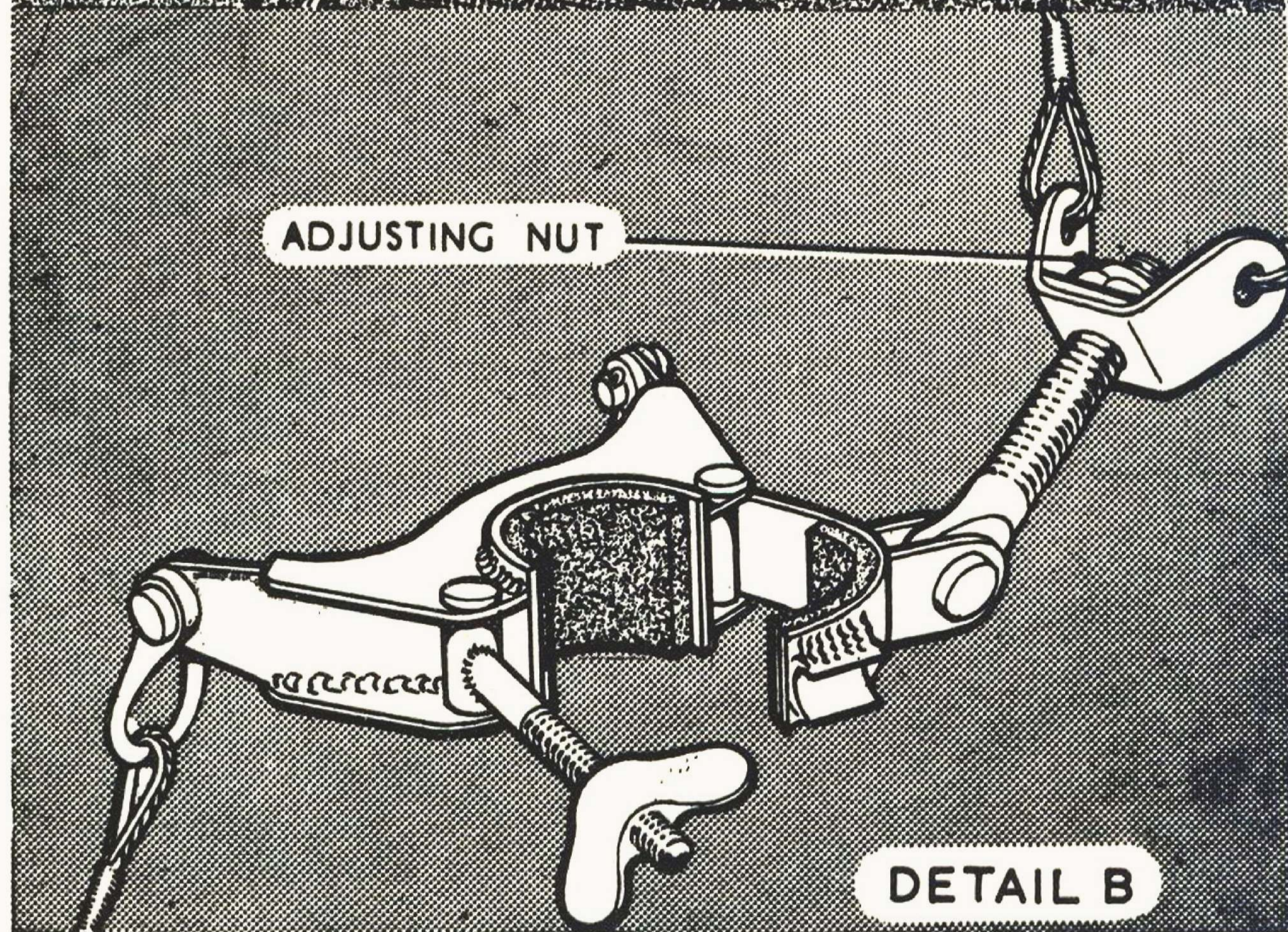
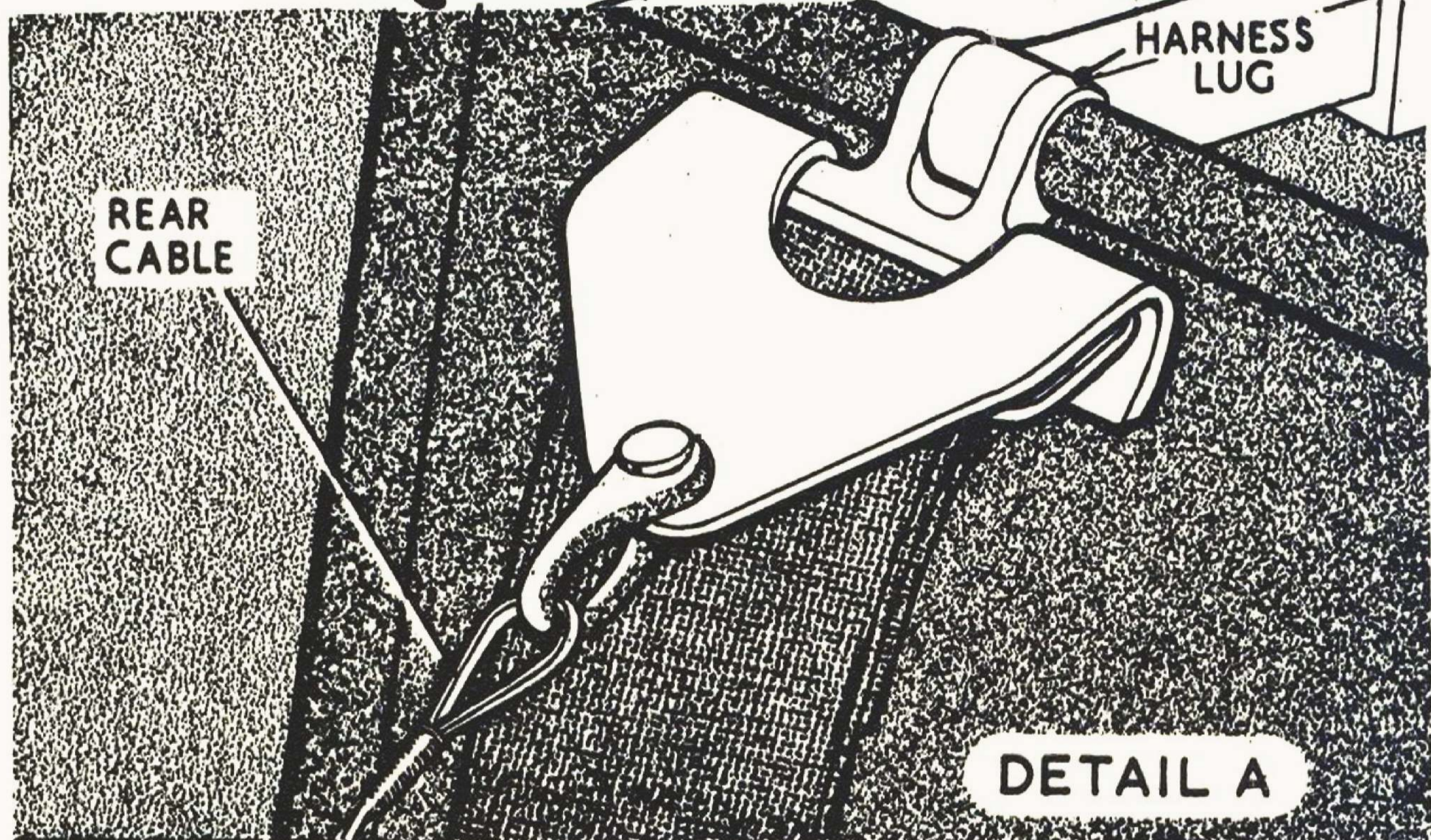
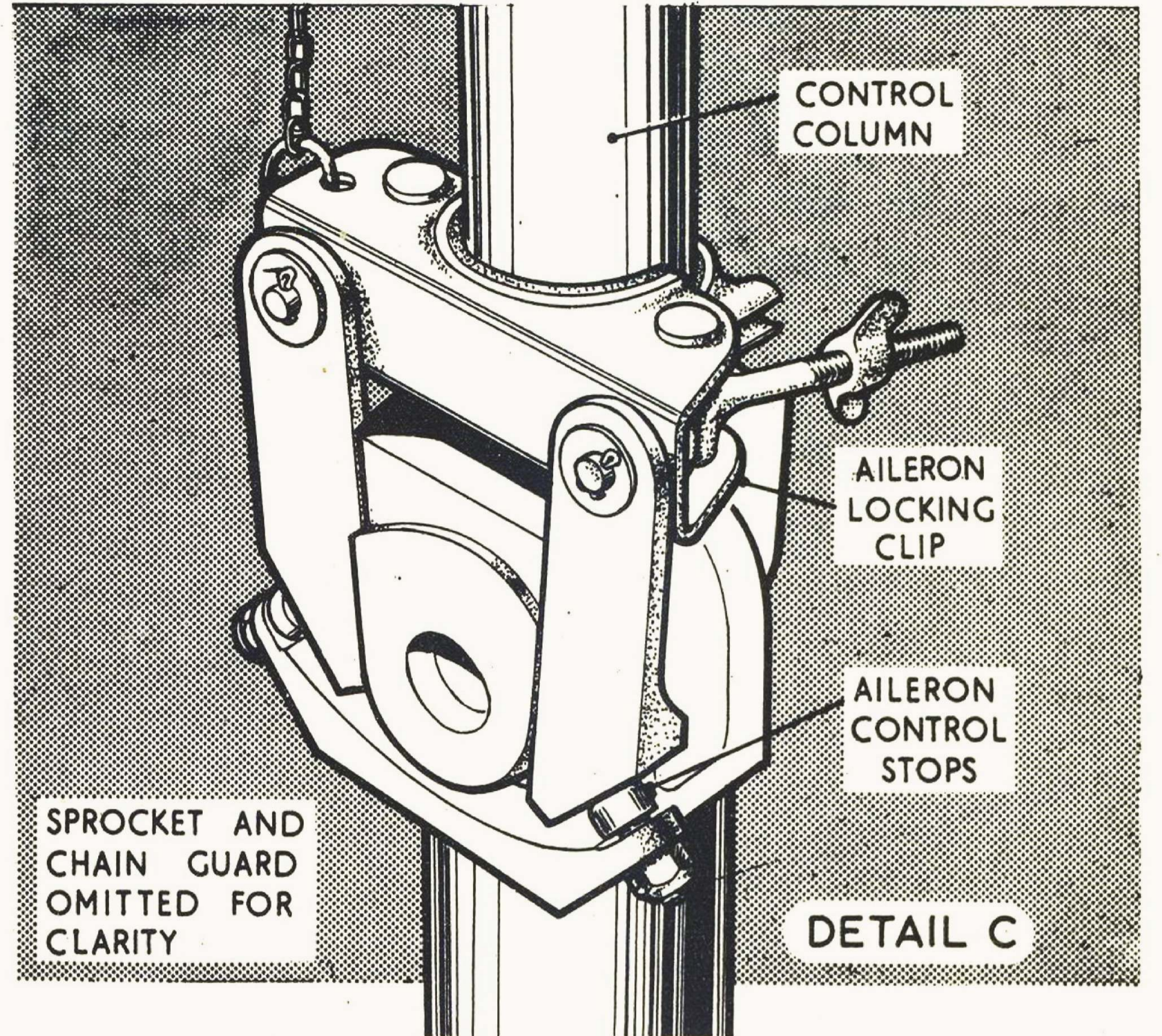
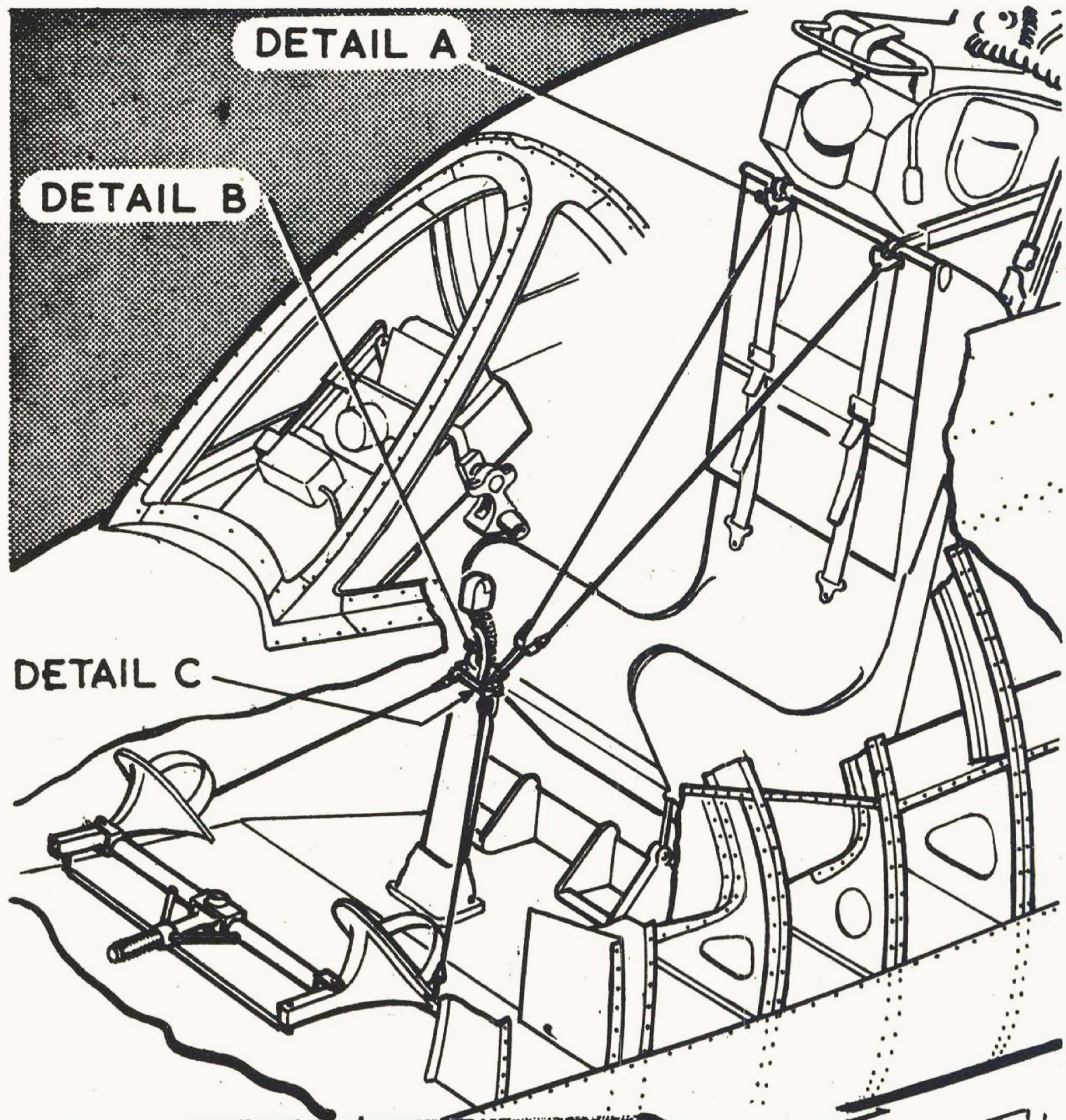

FIG. 4 FLYING CONTROLS LOCKING GEAR

1. SHOCK ABSORBER CORD
2. AILERON LOCKING PLATE
3. RELEASE HOOK
4. RUDDER LOCKING PLATE
5. ATTACHMENT RING
6. WING BOLT
7. SHOCK ABSORBER CORD
8. ELEVATOR LOCK
9. AILERON LOCK COMPLETE WITH STRAP & SHOCK ABSORBER CORD

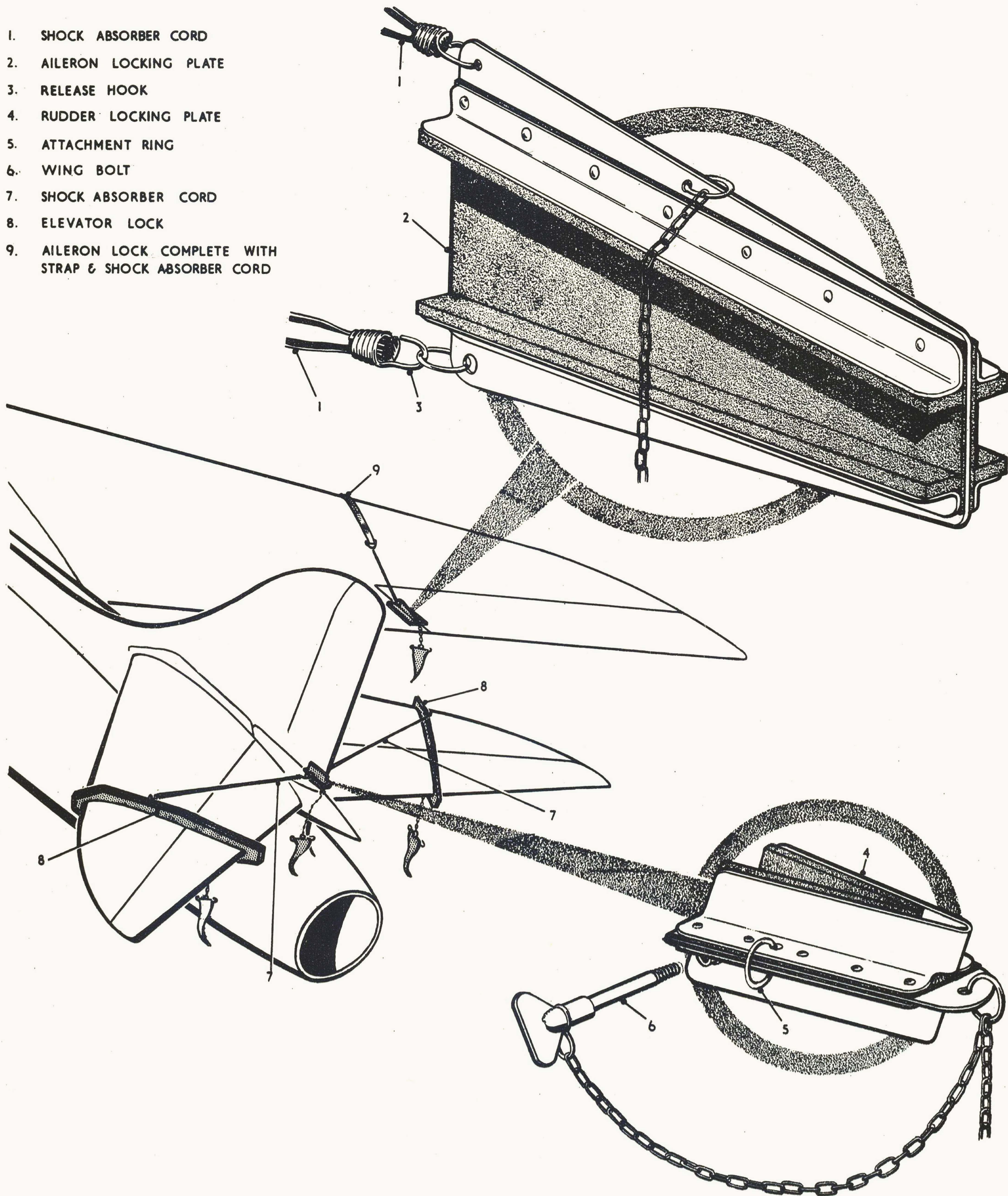

FIG. 5 CONTROL SURFACE LOCKING CLAMPS

one end and a wing nut at the other. The fork is fitted to a lug on the nose wheel jack piston by a quick-release pin and the other end is passed through a hole in the clamping bar, which bridges the nose wheel aperture in the fuselage, after which the whole assembly is tensioned by the wing nut. The stops for the main undercarriage legs consist of sleeves which pass round the operating jack piston rods, the sleeves being secured in position by trunnion bolts and wing nuts. Each sleeve is provided with shims for initial adjustment. To safeguard against the aircraft being flown with the stops still in position, red warning pennants, which must not be removed, are attached to each stop.

Parking with brakes on

11. When the aircraft is left parked with the brakes on, for any length of time, the flying control locking gear must be fitted to prevent loss of pressure from the hydraulic accumulators due to movement of the rudder bar. Such loss of pressure will release the brakes and prevent them from being used again until the accumulators are re-energized.

Care of engine

12. If the aircraft is left standing without the engine being run-up for more than seven days, the engine must be inhibited as a precaution against corrosion in accordance with the instructions contained in the engine handbook. All apertures should be suitably blanked off to exclude the ingress of dirt and moisture; rag must not be used for this purpose.

Moving a crashed aircraft (fig.7)

13. The procedure for moving an aircraft which has crashed in any of the following three conditions is shown on this illustration, the necessary operations also being covered:-

- (1) With the nose and main undercarriage undamaged.
- (2) With the nose undercarriage damaged.
- (3) With both nose and main undercarriage damaged.

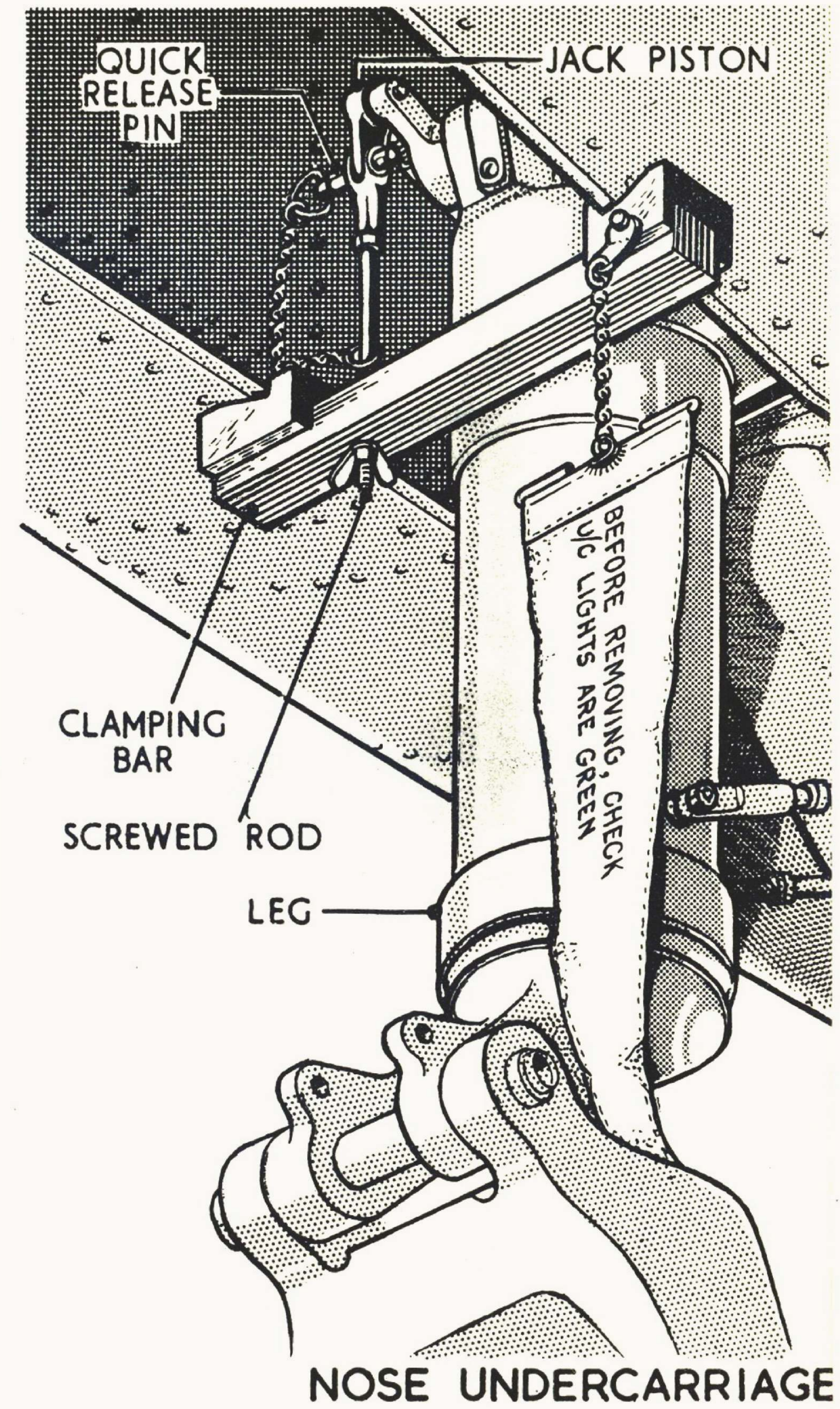
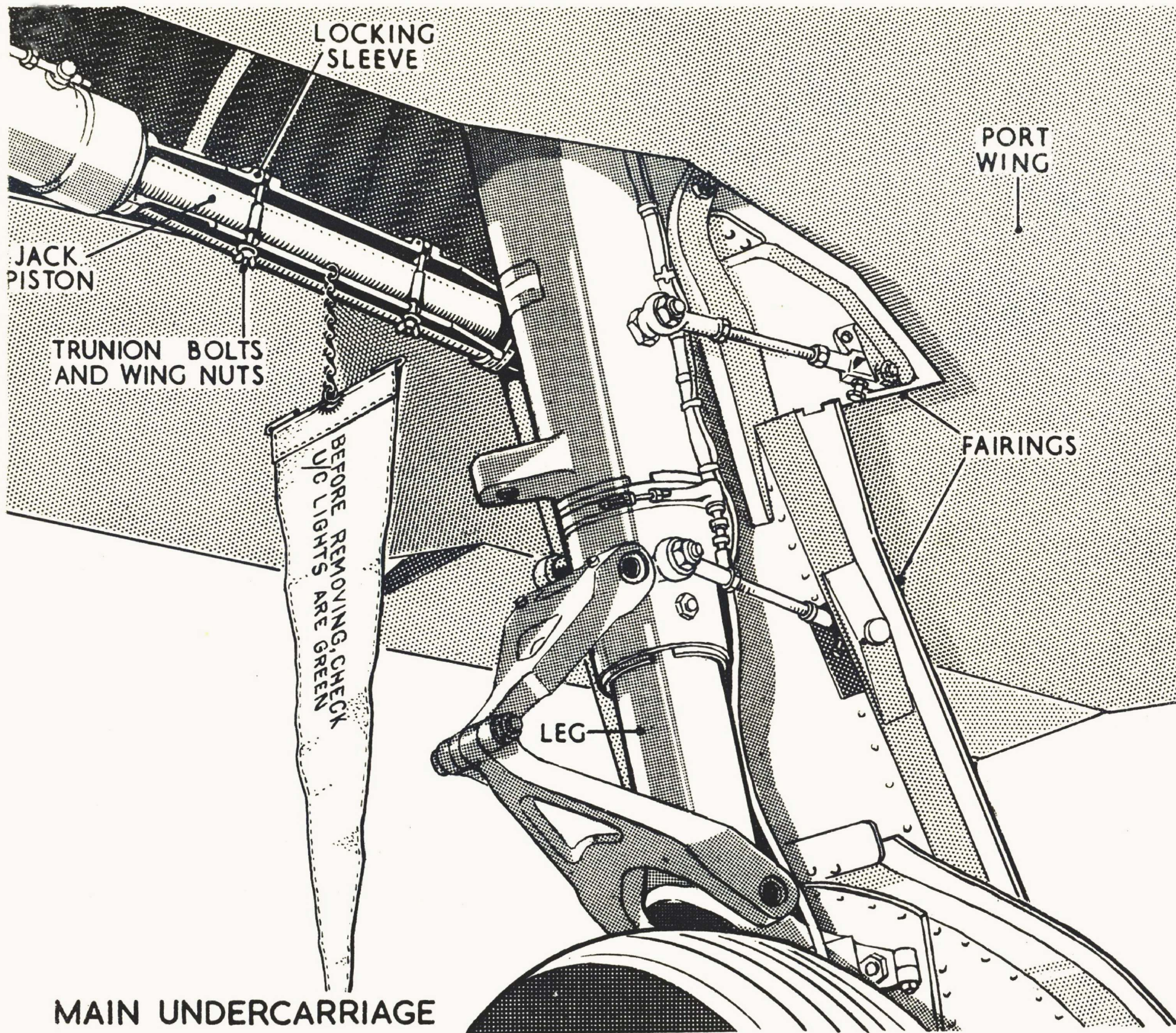
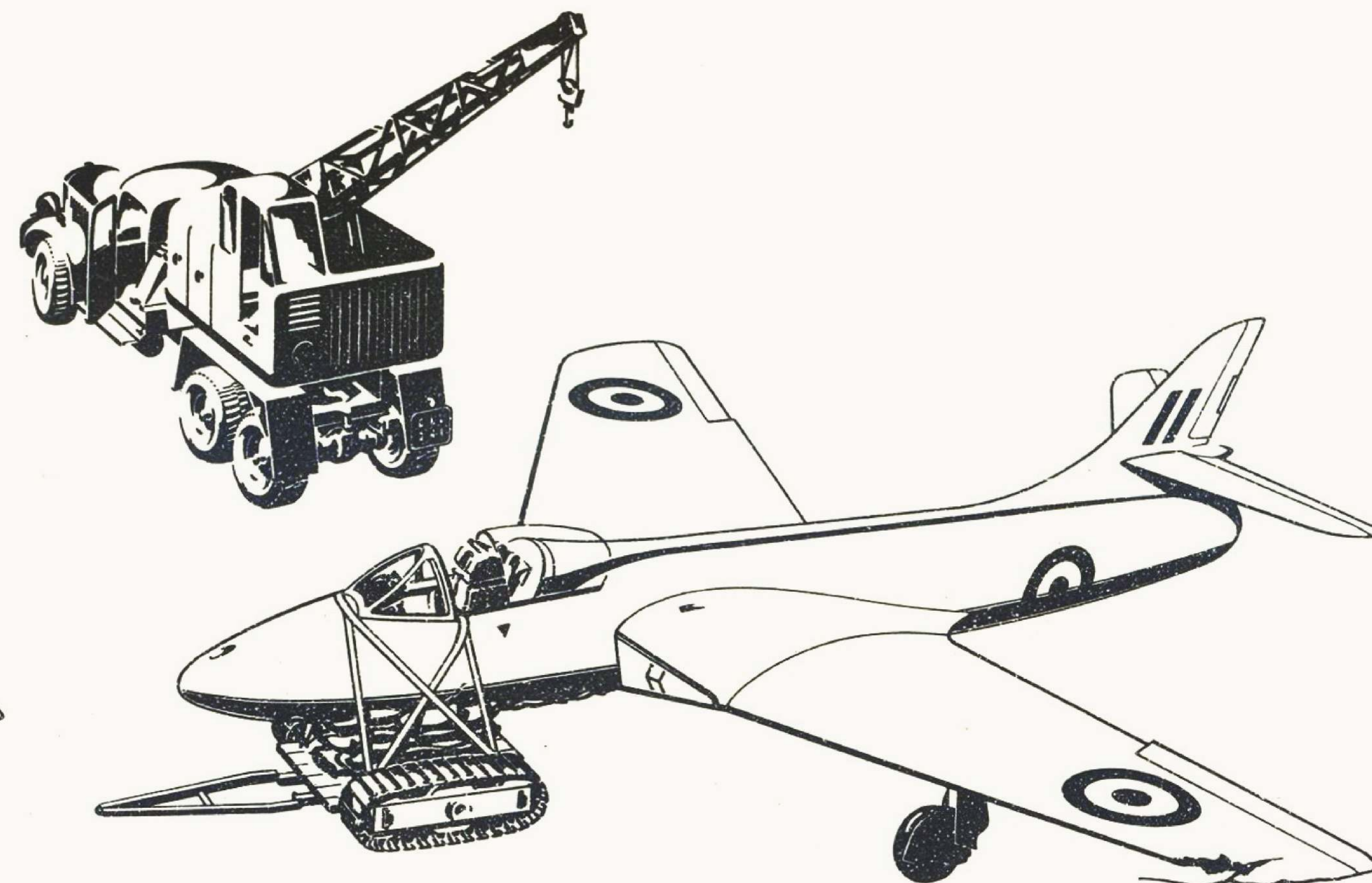
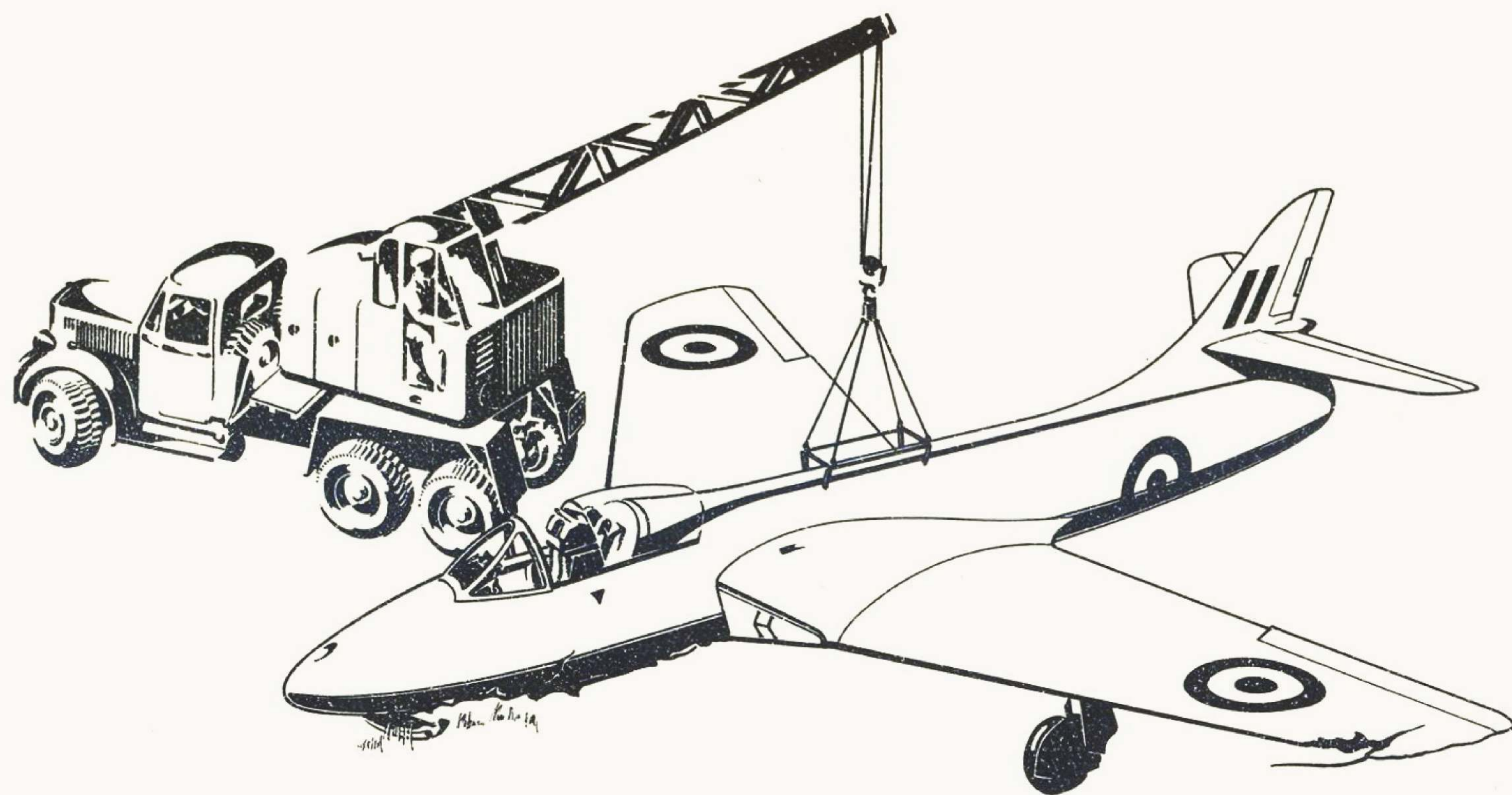

FIG. 6 UNDERCARRIAGE SAFETY STOPS



1. COVER THE AIR INTAKES AND EXIT TO PREVENT THE ENTRY OF FURTHER GRIT AND DUST. ATTACH THE COMPLETE-AIRCRAFT TYPE SLING (SECT. 2, CHAP. 4) AND RAISE THE AIRCRAFT. LOWER THE ALIGHTING GEAR AND CHECK THAT IT IS LOCKED AND UNDEMANAGED. LOWER THE AIRCRAFT, ATTACH A TOWING ARM TO THE NOSE UNDERCARRIAGE AND, WITH A MAN IN CONTROL OF THE AIRCRAFT BRAKES, TOW THE AIRCRAFT FORWARDS.

2. IF THE NOSE UNDERCARRIAGE IS DAMAGED AND JAMMED UP, AND THE MAIN UNDERCARRIAGE IS UNDEMANAGED, MOVE A SALVAGE TROLLEY TYPE B (STORES REF. 4G/3735) PADDED WITH SANDBAGS, UNDER THE NOSE AND SECURE THE FUSELAGE TO THE TROLLEY. ATTACH A TOWING BAR TO THE TROLLEY AND, WITH A MAN IN CONTROL OF THE AIRCRAFT BRAKES, TOW THE AIRCRAFT FORWARDS.

WARNING . . .

Do not interfere with any part of the ejection seat, except to release or cut through the pilot's harness, until the cartridge firing devices have been rendered safe (Sect. 1, Chap. 3).

Do not attempt to remove the cartridges.

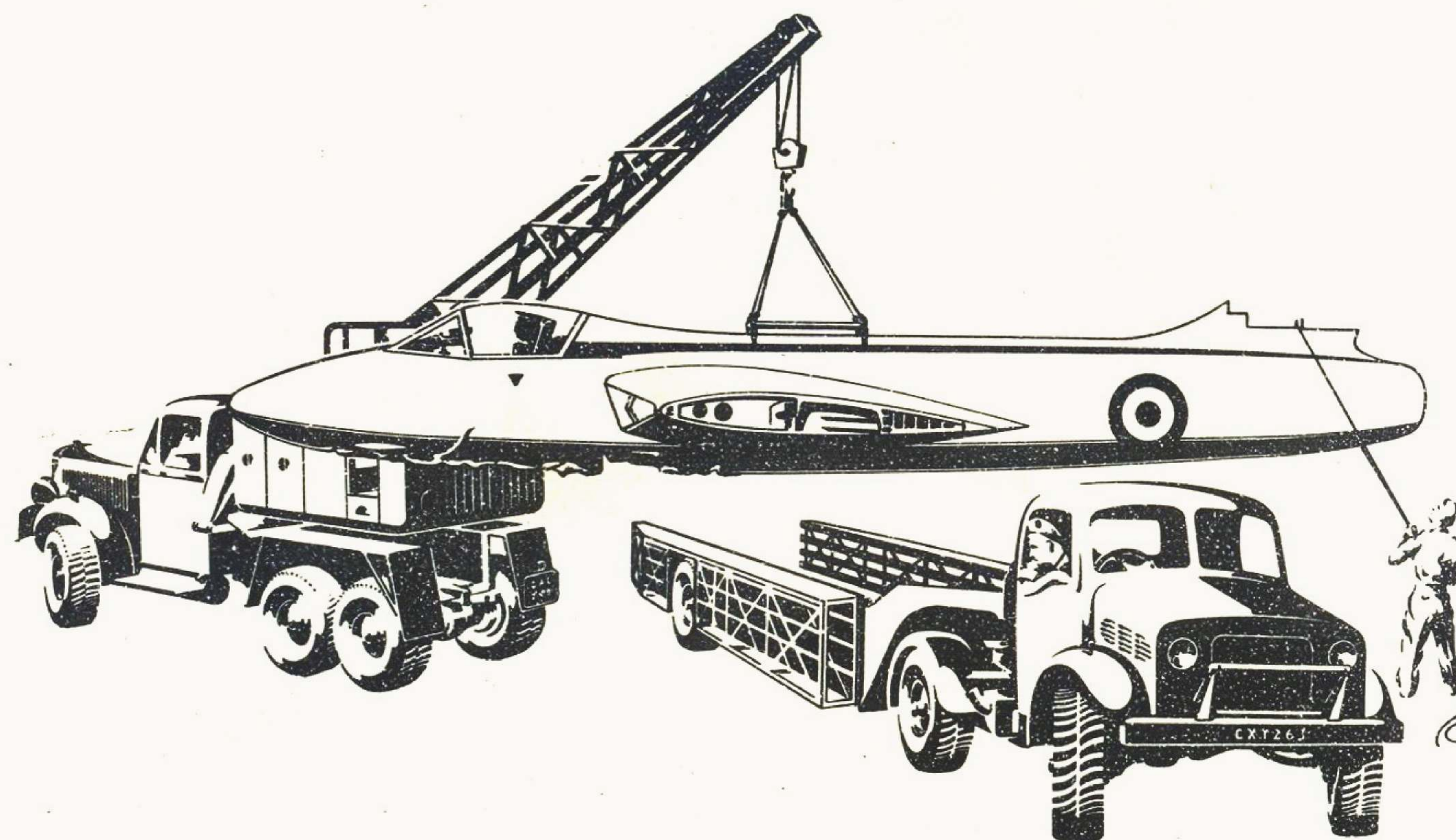
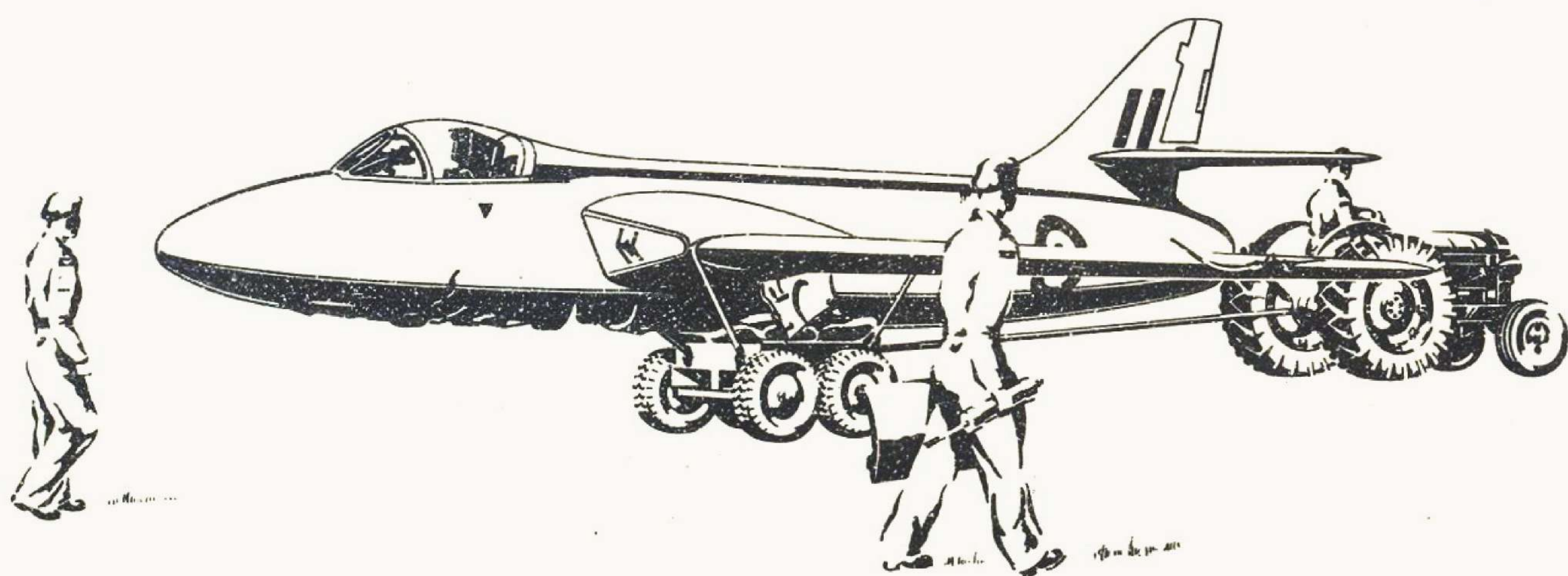

3. IF THE MAIN AND NOSE UNDERCARRIAGE ARE DAMAGED, LOWER THE AIRCRAFT ON TO A SALVAGE TROLLEY TYPE A (STORES REF. 4G/3730) OR TYPE C (STORES REF. 4G/3732), PADDED WITH SANDBAGS AS SHOWN, MAKING SURE THAT THE C.G. OF THE AIRCRAFT IS, AS NEAR AS POSSIBLE, OVER THE CENTRE OF THE TROLLEY. LASH THE AIRCRAFT TO THE TROLLEY AND, WITH PERSONNEL STATIONED TO STEADY THE AIRCRAFT, TOW THE AIRCRAFT AWAY.

4. REMOVE THE WINGS, ELEVATOR, ANTI-BUFFET FAIRING, RUDDER AND FIN. SLING THE AIRCRAFT WITH THE SALVAGE TYPE SLING, STEADYING THE FUSELAGE WITH GUIDE ROPES. LOWER THE AIRCRAFT ON TO THE TRAILER WITH THE NOSE TO THE DRIVER'S CABIN, SETTLING THE FUSELAGE ON TRESTLES AT FRAMES 9, 25, 37 AND 52. THE TRESTLES ARE TO BE TEMPORARILY SECURED TO THE TRAILER TO PREVENT MOVEMENT DURING TRANSIT. LOAD THE REMAINING STRUCTURE ON A SECOND TRAILER.

FIG. 7 LIFTING A CRASHED AIRCRAFT

